



# BASKETBALL SET

## FLY NLC45

Μπασκέτα με Βάση | Basketball Set

(Οδηγίες Συναρμολόγησης | Assembly Instructions)

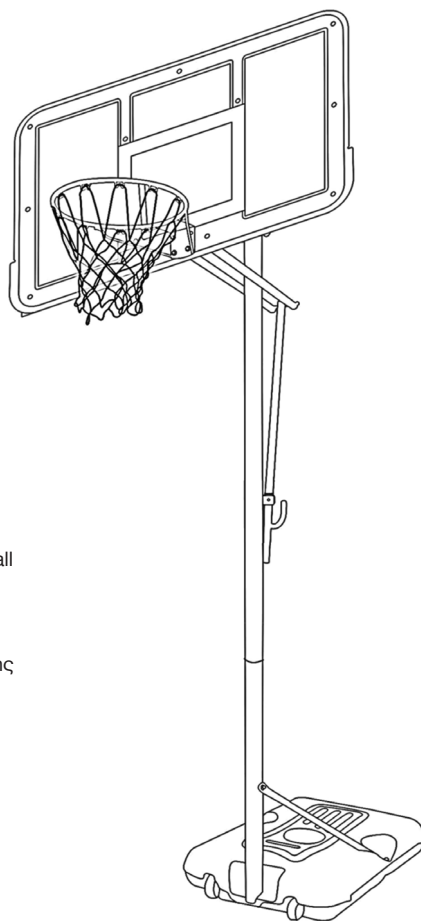

Μάθε περισσότερα για τη  
μπασκέτα σκανάροντας το QR  
Learn more about the basketball  
set by scanning the QR



Δείτε το βίντεο συναρμολόγησης  
σκανάροντας το QR  
Scan the code to view a  
short assembly video

[www.amila.gr](http://www.amila.gr)











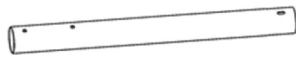
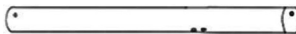



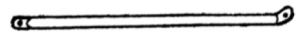

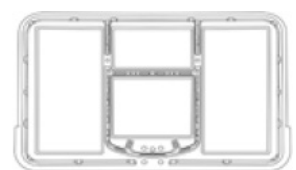

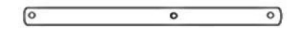
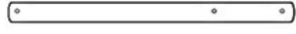

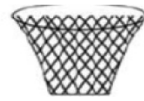













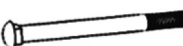

Όπου υπάρχει AMILA,  
**ΥΠΑΡΧΟΥΝ ΝΙΚΗΤΕΣ.**

ITEM NO.: 49206





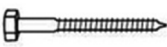

Where there is AMILA,  
**THERE ARE WINNERS.**

## ΜΕΡΗ/ΕΞΑΡΤΗΜΑΤΑ ΣΥΝΑΡΜΟΛΟΓΗΣΗΣ

#	Περιγραφή	Σχήμα
A	Άνω στύλος Ø76,2x879mm (1 τμχ.)	
B	Μεσαίος στύλος Ø76,2x1079mm (1 τμχ.)	
C	Κάτω στύλος Ø76,2x1079mm (1 τμχ.)	
D	Ρυθμιστής ύψους (1 τμχ.)	
E	Βάση (1 τμχ.)	
F	Δεξί και αριστερό στήριγμα Ø25,4x835mm (2 τμχ.)	
G	Τροχός (2 τμχ.)	
H	Άξονας Ø12x556mm (1 τμχ.)	
I	Ταμπλό (1 τμχ.)	
J	Στήριγμα ταμπλό σχήματος "Υ" (2 τμχ.)	
K	Πίσω σωλήνας (επάνω) Ø38,1x480mm (2 τμχ.)	
L	Πίσω σωλήνας (κάτω) Ø38,1x720mm (2 τμχ.)	
M	Στεφάνι Ø16mm (1 τμχ.)	
N	Δίκτυ (1 τμχ.)	
O	Ελατήριο (1 τμχ.)	
P	Καπάκι ρυθμιστή ύψους Ø38,1mm (2 τμχ.)	
Q	Καπάκι άνω στύλου (1 τμχ.)	
R	Ροδέλες τροχών 13x25x2mm (4 τμχ.)	



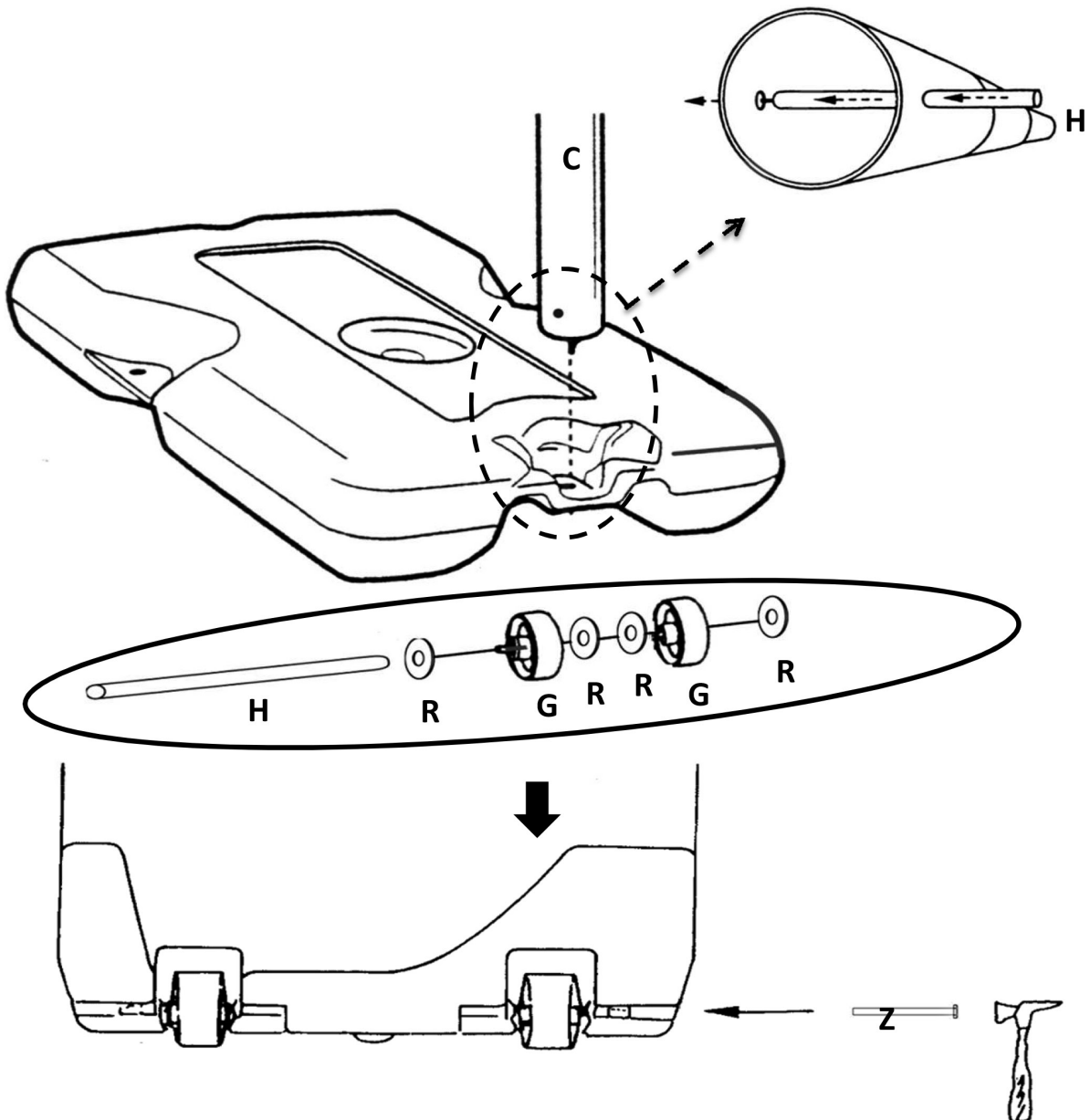

#	Περιγραφή	Σχήμα
S	Βίδα με εξάγωνο κεφάλι για τη βάση M8x25mm (2 τμχ.)	
T	Βίδα με εξάγωνο κεφάλι M8x90mm (1 τμχ.)	
U	Ροδέλα 8,2x20x2mm (18 τμχ.)	
V	Παξιμάδι ασφαλείας M8 (9 τμχ.)	
W	Βίδα με εξάγωνο κεφάλι για το ταμπλό M8x38mm (4 τμχ.)	
X	Βίδα με εξάγωνο κεφάλι 3/8" x 165mm (6 τμχ.)	
Y	Παξιμάδι ασφαλείας 3/8" (6 τμχ.)	
Z	Ράβδος με εξάγωνο κεφάλι Ø9,2x142mm (1 τμχ.)	
AA	Βίδα με στρογγυλό κεφάλι και τετράγωνο λαιμό 1/4" x 87mm (2 τμχ.)	
BB	Παξιμάδι ασφαλείας 1/4" (2 τμχ.)	
CC	Βίδα σταυρός M8x35mm (2 τμχ.)	
DD	Παξιμάδι M8 (2 τμχ.)	
EE	Υποδοχέας σχήματος "U" (1 τμχ.)	
FF	Βίδα με εξάγωνο κεφάλι M8x88mm (2 τμχ.)	
GG	Σιδερένιο σωληνάκι 10,5x12,7x42mm (2 τμχ.)	
HH	Πλαστικός σωλήνας 13,2x16,8x15,6mm (4 τμχ.)	
II	Πλαστικός σωλήνας 9,6x13x19mm (2 τμχ.)	
JJ	Πείρος ασφαλείας (1 τμχ.)	
KK	Βίδα με εξάγωνο κεφάλι 5/16" x 6" (4 τμχ.)	
LL	Καπάκι βάσης (1 τμχ.)	
MM	Πλαστικό καπάκι για ρυθμιστή ύψους Ø25,4mm (1 τμχ.)	

## ΒΗΜΑ 1: Βάση

#	Περιγραφή	Σχήμα
C	Κάτω στύλος $\varnothing 76,2 \times 1079 \text{mm}$ (1 τμχ.)	
E	Βάση (1 τμχ.)	
G	Τροχός (2 τμχ.)	
H	Άξονας $\varnothing 12 \times 556 \text{mm}$ (1 τμχ.)	
R	Ροδέλες τροχών $13 \times 25 \times 2 \text{mm}$ (4 τμχ.)	
Z	Ράβδος με εξάγωνο κεφάλι $\varnothing 9,2 \times 142 \text{mm}$ (1 τμχ.)	



**ΒΗΜΑ 2: Κάτω στύλος και στηρίγματα**

#	Περιγραφή	Σχήμα
T	Βίδα με εξάγωνο κεφάλι M8x90mm (1 τμχ.)	
U	Ροδέλα 8,2x20x2mm (6 τμχ.)	
V	Παξιμάδι ασφαλείας M8 (3 τμχ.)	
S	Βίδα με εξάγωνο κεφάλι για τη βάση M8x25mm (2 τμχ.)	
F	Δεξί και αριστερό στήριγμα Ø25,4x835mm (2 τμχ.)	

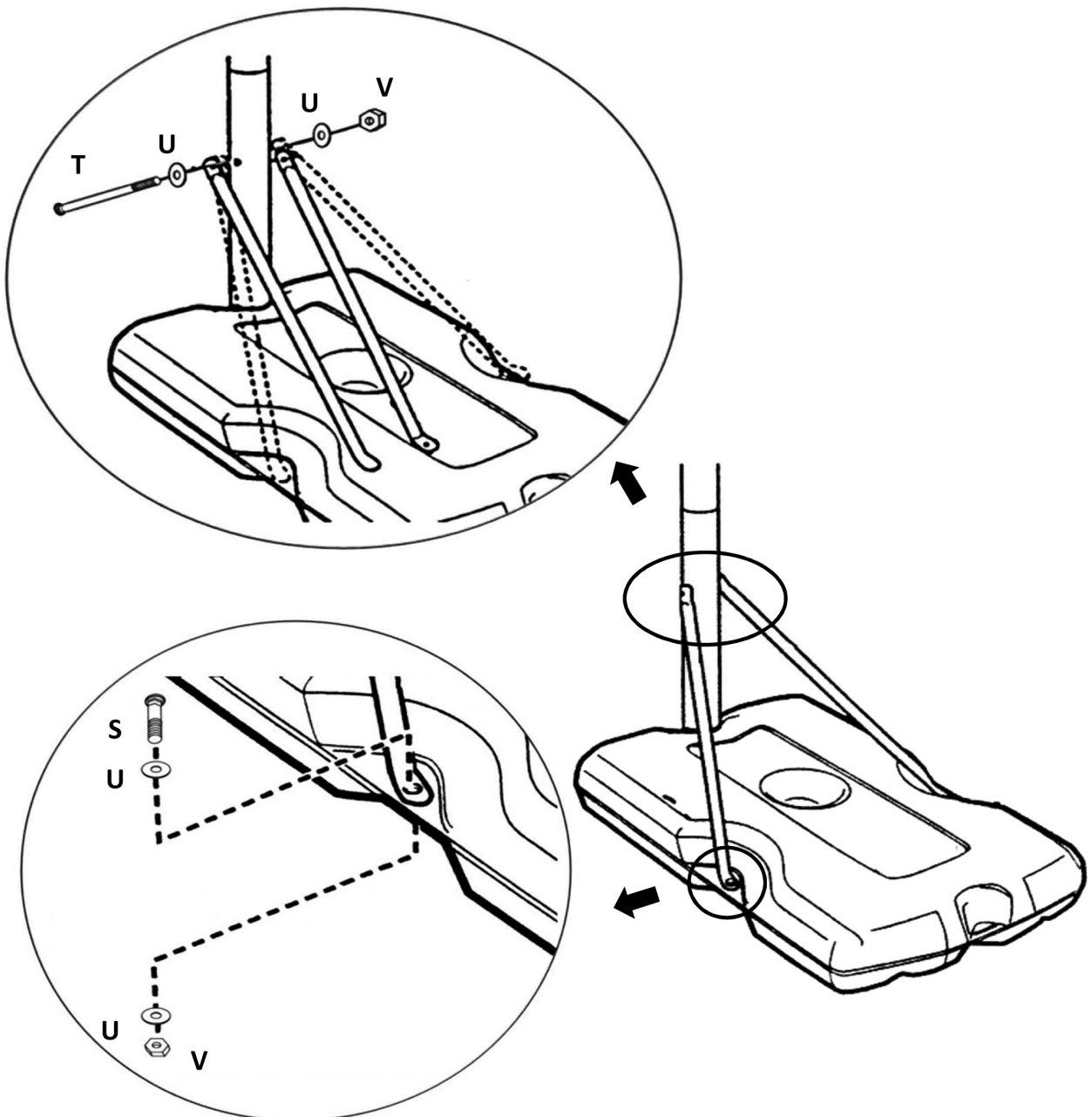



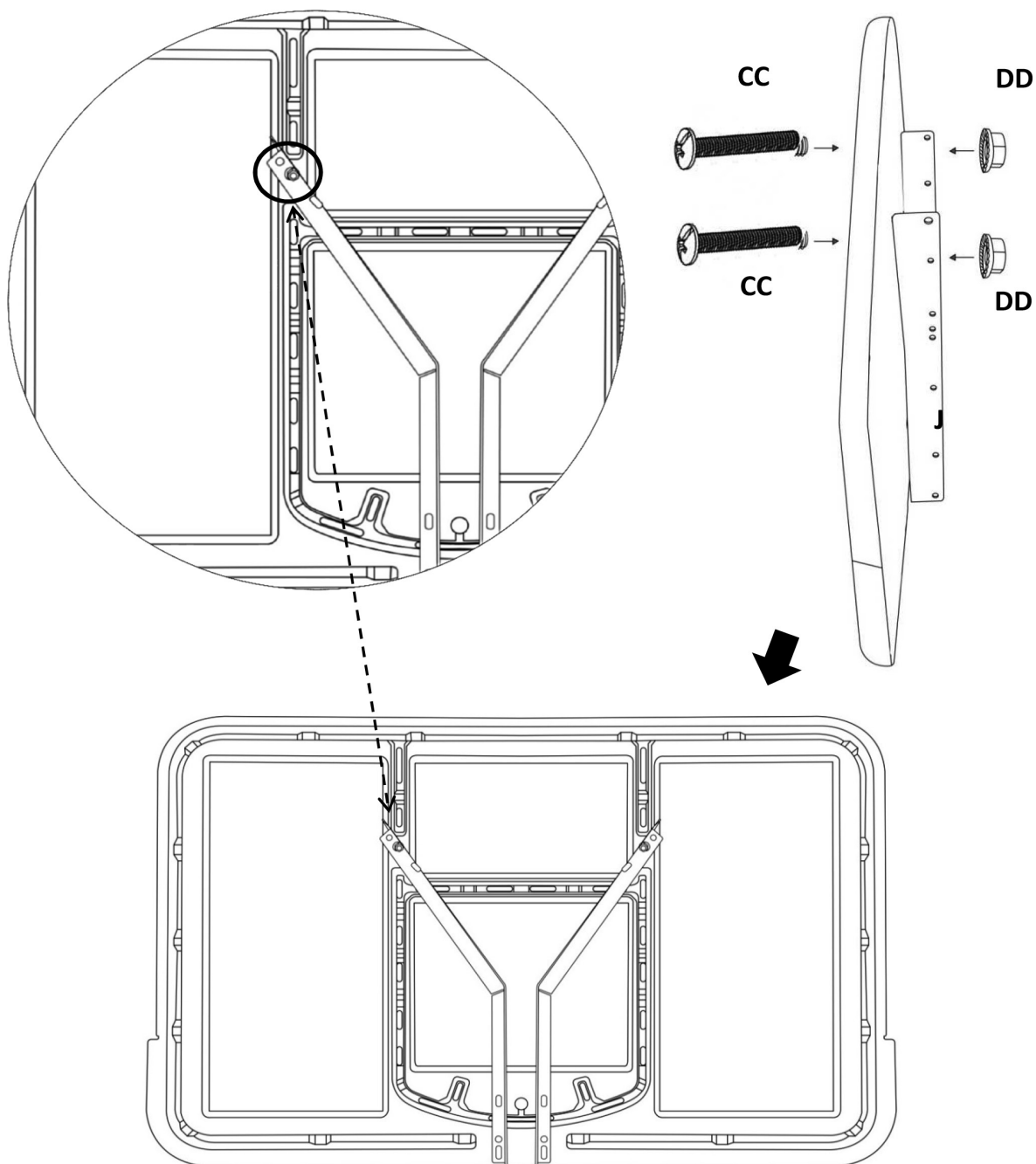

**ΒΗΜΑ 3: Στηρίγματα ταμπλό**

#	Περιγραφή	Σχήμα
I	Ταμπλό (1 τμχ.)	
J	Στήριγμα ταμπλό σχήματος "Υ" (2 τμχ.)	
CC	Βίδα σταυρός M8x35mm (2 τμχ.)	
DD	Παξιμάδι M8 (2 τμχ.)	



#### ΒΗΜΑ 4: Στεφάνι

GR

#	Περιγραφή	Σχήμα
U	Ροδέλα 8,2x20x2mm (8 τμχ.)	
V	Παξιμάδι ασφαλείας M8 (4 τμχ.)	
W	Βίδα με εξάγωνο κεφάλι για το ταμπλό M8x38mm (4 τμχ.)	
M	Στεφάνι Ø16mm (1 τμχ.)	
N	Δίχτυ (1 τμχ.)	

#### ΣΗΜΕΙΩΣΗ:

Εγκαταστήστε το δίχτυ αφού στερεώσετε το στεφάνι και τα στηρίγματα στο ταμπλό

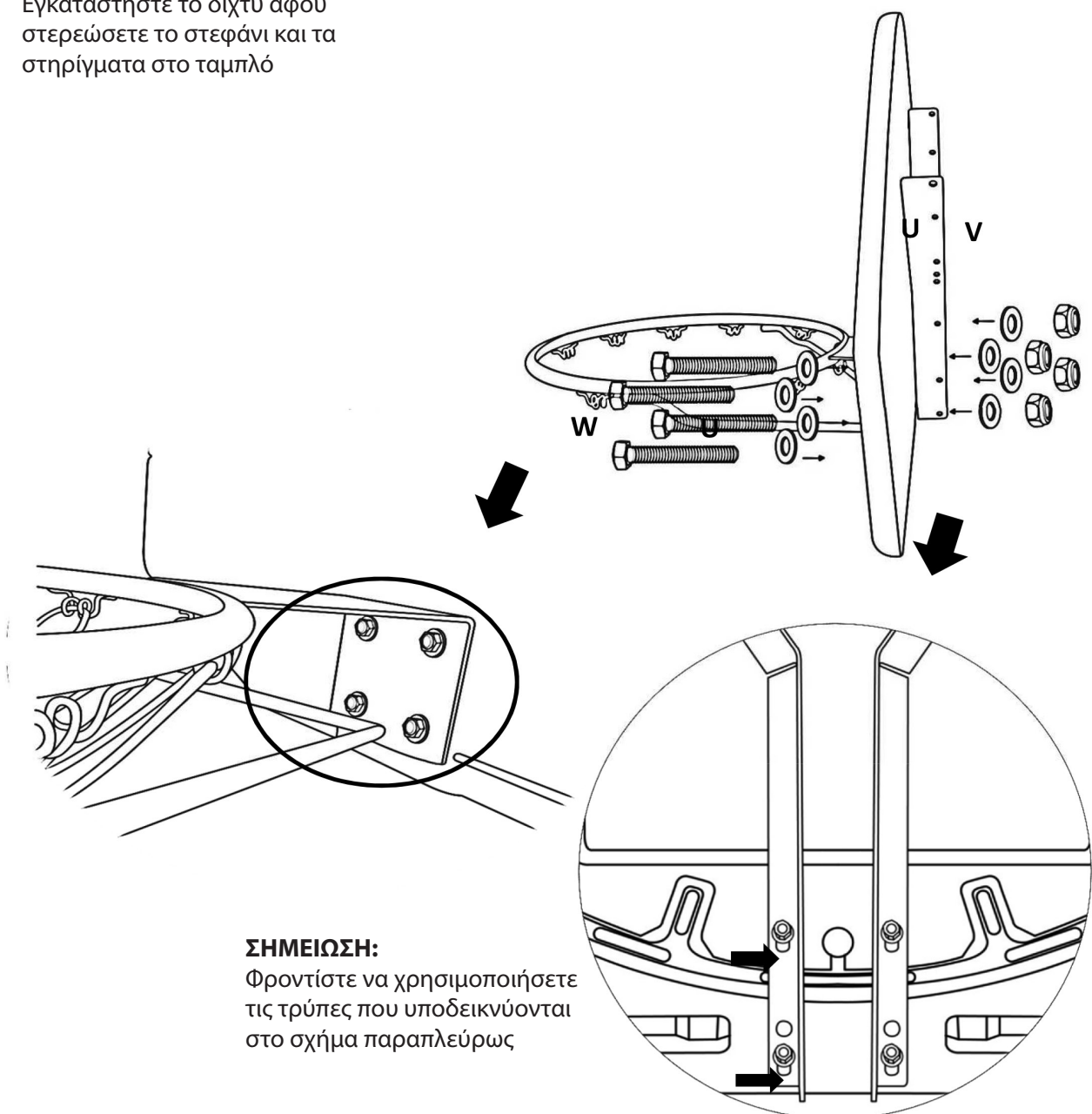

**ΒΗΜΑ 5-1: Σωλήνες πίσω από το ταμπλό (1/2)**

#	Περιγραφή	Σχήμα
K	Πίσω σωλήνας (επάνω) Ø38,1x480mm (2 τμχ.)	
L	Πίσω σωλήνας (κάτω) Ø38,1x720mm (2 τμχ.)	
X	Βίδα με εξάγωνο κεφάλι 3/8" x 165mm (2 τμχ.)	
Y	Παξιμάδι ασφαλείας 3/8" (2 τμχ.)	
GG	Σιδερένιο σωληνάκι 10,5x12,7x42mm (2 τμχ.)	
HH	Πλαστικός σωλήνας 13,2x16,8x15,6mm (4 τμχ.)	

**ΣΗΜΕΙΩΣΗ:**

Η άκρη με τη μεγαλύτερη απόσταση τρυπών είναι αυτή που στερεώνεται στο ταμπλό

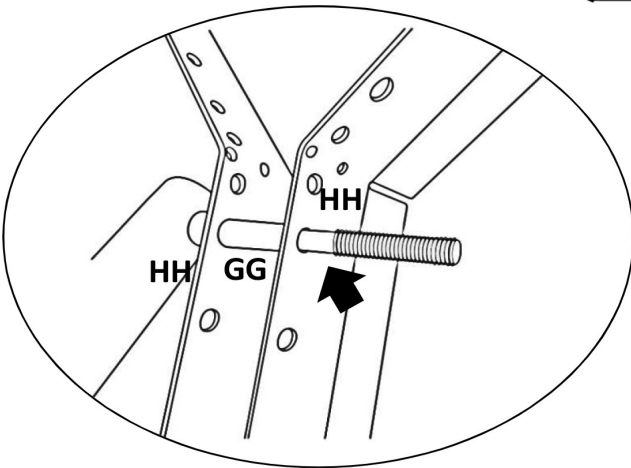
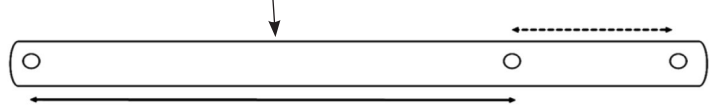
**ΣΗΜΕΙΩΣΗ:**

Τοποθετήστε τα σωληνάκια (GG & HH) στη σωστή θέση

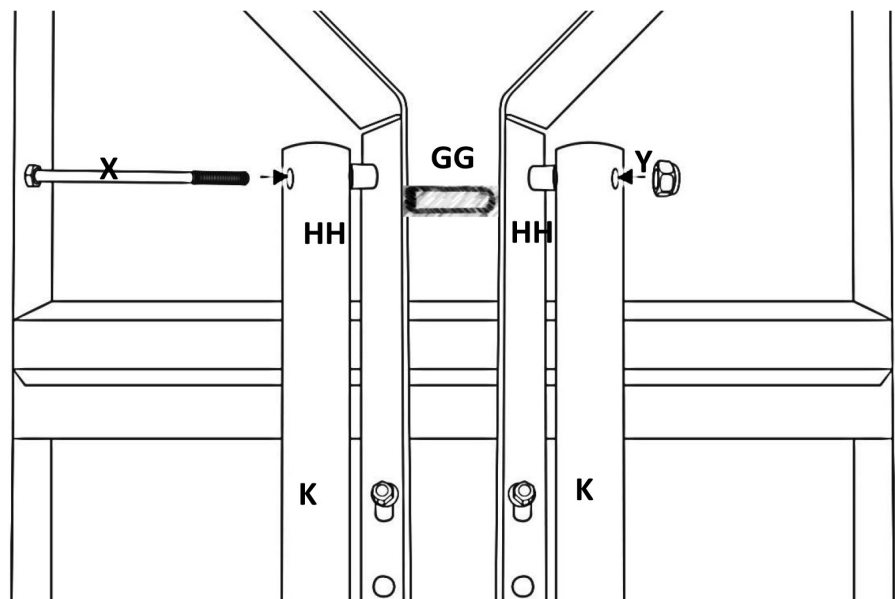



## ΒΗΜΑ 5-2: Σωλήνες πίσω από το ταμπλό (2/2)

GR

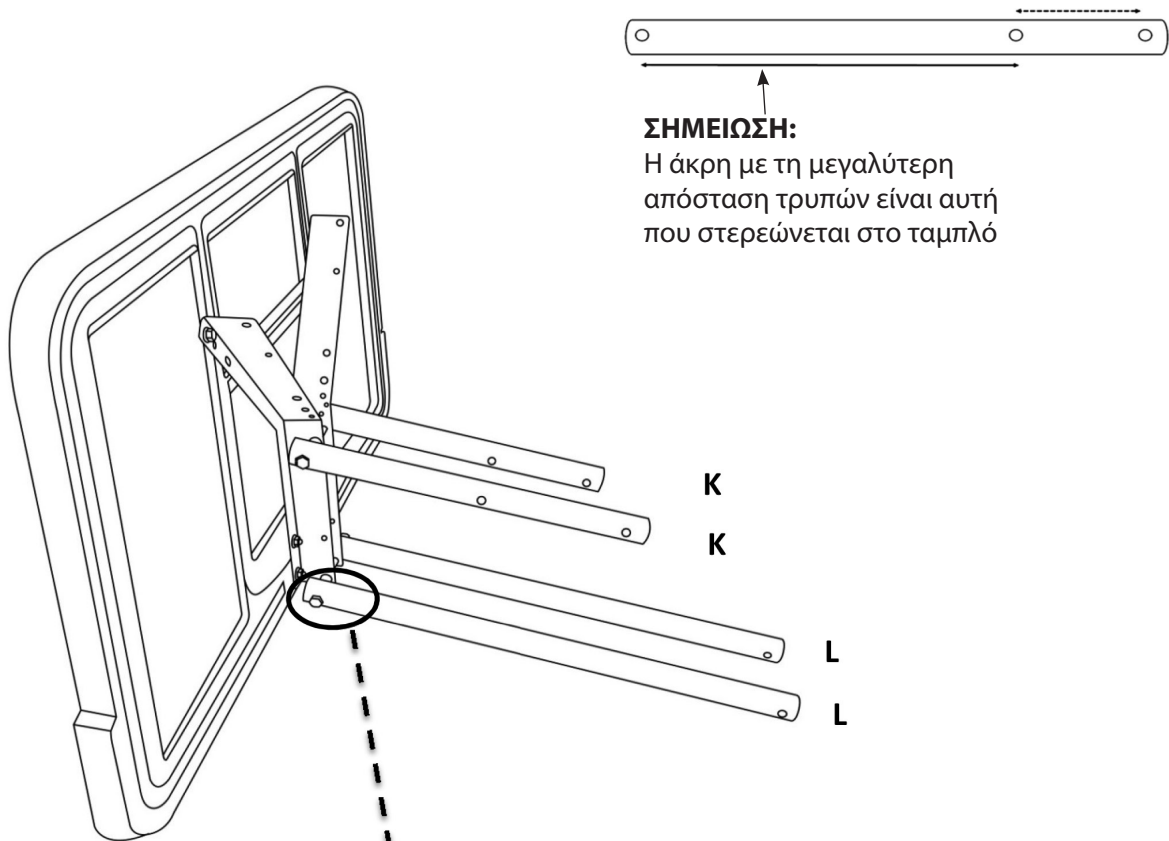

### ΣΗΜΕΙΩΣΗ:



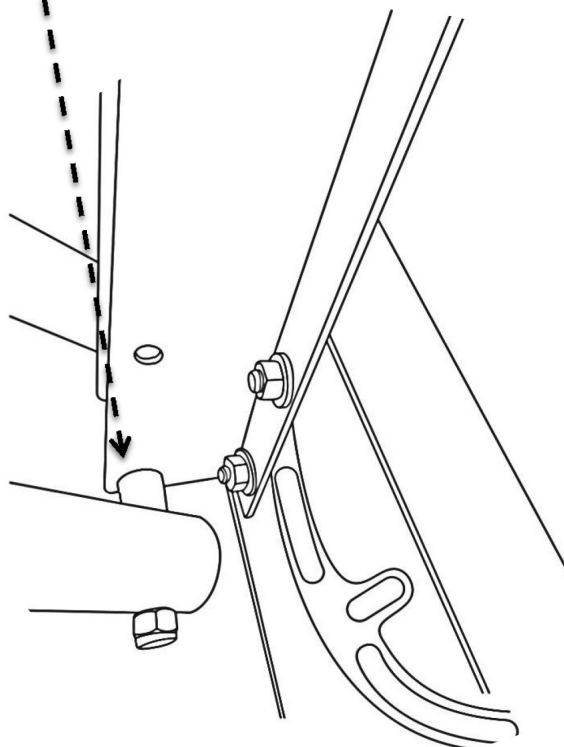

Χρησιμοποιήστε την κατώτατη τρύπα των στηριγμάτων ταμπλό σχήματος «Υ»

### ΣΗΜΕΙΩΣΗ:

Η βίδα, παξιμάδια και σωληνάκια είναι τα ίδια όπως και στο προηγούμενο βήμα, στο κάτω μέρος της προηγούμενης σελίδας

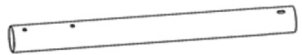

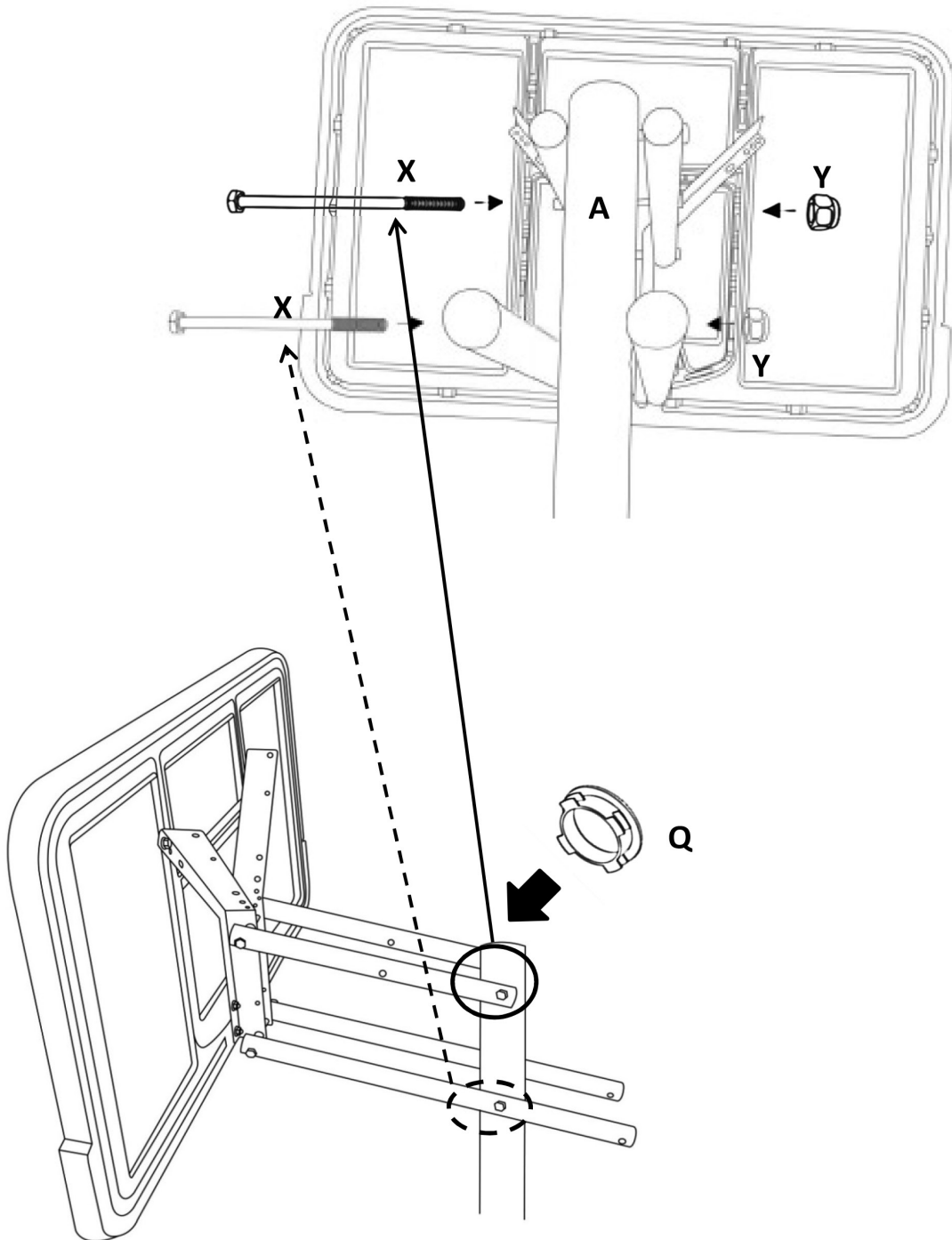

**ΒΗΜΑ 6: Σύνδεση ταμπλό στον άνω στύλο**

#	Περιγραφή	Σχήμα
A	Άνω στύλος Ø76,2x879mm (1 τμχ.)	
X	Βίδα με εξάγωνο κεφάλι 3/8"x165mm (2 τμχ.)	
Y	Παξιμάδι ασφαλείας 3/8" (2 τμχ.)	
Q	Καπάκι άνω στύλου (1 τμχ.)	



## ΒΗΜΑ 7: Ελατήριο πίσω από το ταμπλό

GR

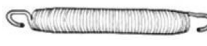
#	Περιγραφή	Σχήμα
X	Βίδα με εξάγωνο κεφάλι 3/8" x 165mm (1 τμχ.)	
Y	Παξιμάδι ασφαλείας 3/8" (1 τμχ.)	
O	Ελατήριο (1 τμχ.)	

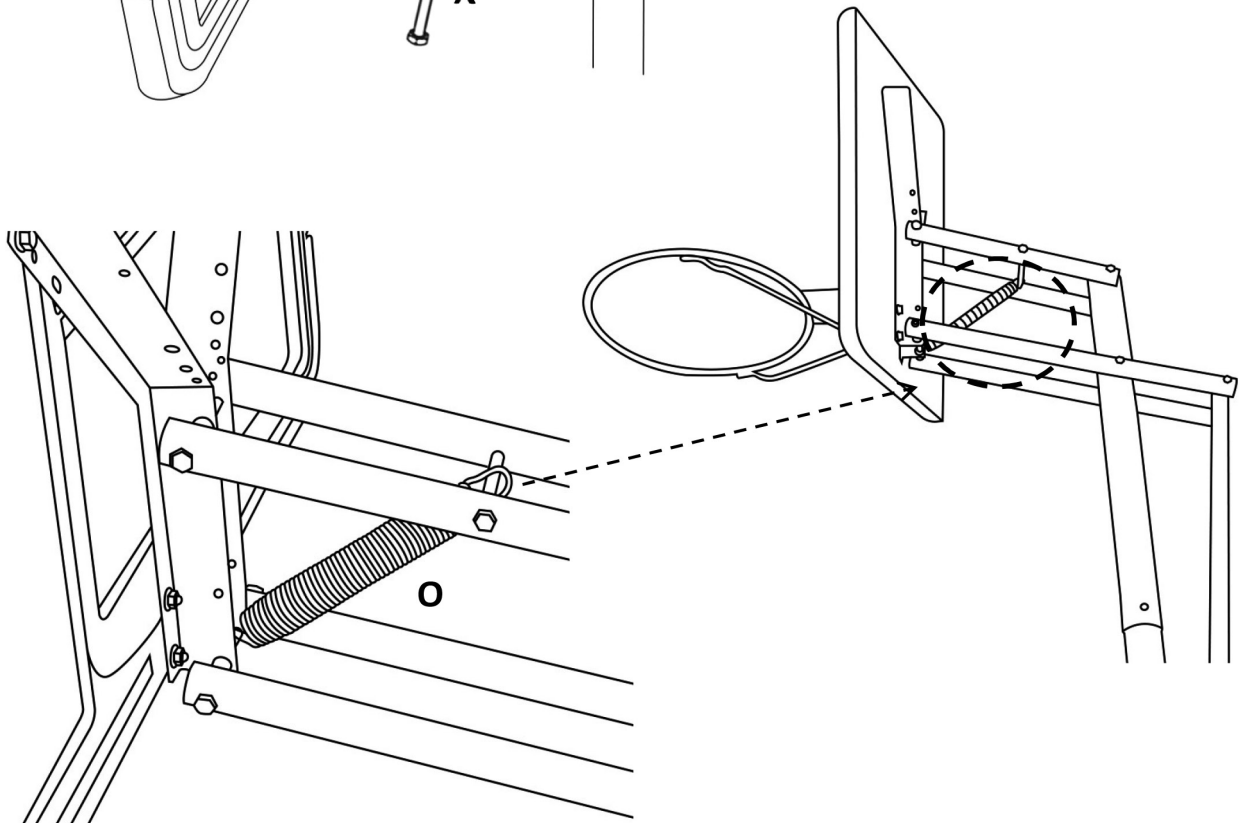
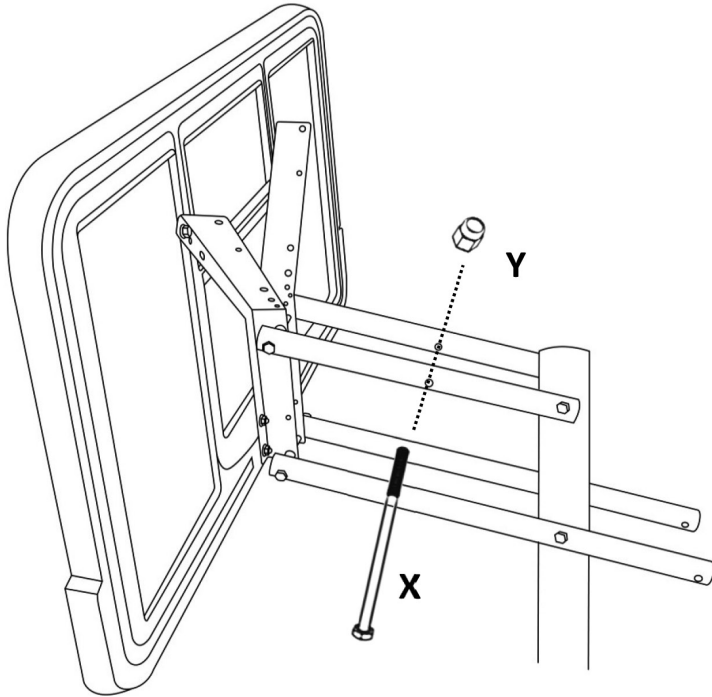

**ΒΗΜΑ 8: Ρυθμιστής ύψους στο μεσαίο στύλο**



#	Περιγραφή	Σχήμα
B	Μεσαίος στύλος $\varnothing 76,2 \times 1079 \text{mm}$ (1 τμχ.)	
D	Ρυθμιστής ύψους (1 τμχ.)	
U	Ροδέλα 8,2x20x2mm (2 τμχ.)	
V	Παξιμάδι ασφαλείας M8 (2 τμχ.)	
EE	Υποδοχέα σχήματος "U" (1 τμχ.)	
FF	Βίδα με εξάγωνο κεφάλι M8x88mm (2 τμχ.)	

**ΣΗΜΕΙΩΣΗ:**

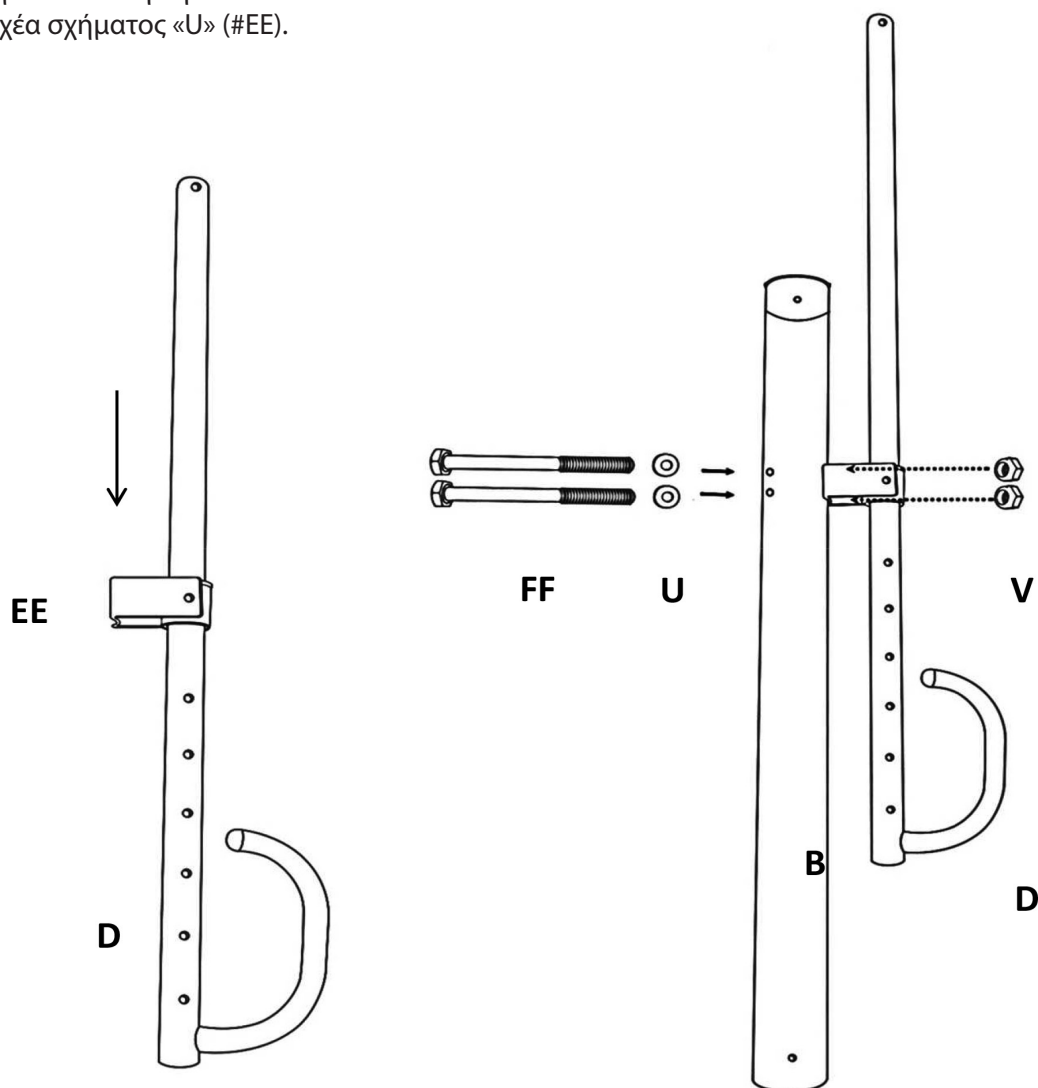
Ο ρυθμιστής ύψους (#D)  
περνά μέσα από την τρύπα του  
υποδοχέα σχήματος «U» (#EE).





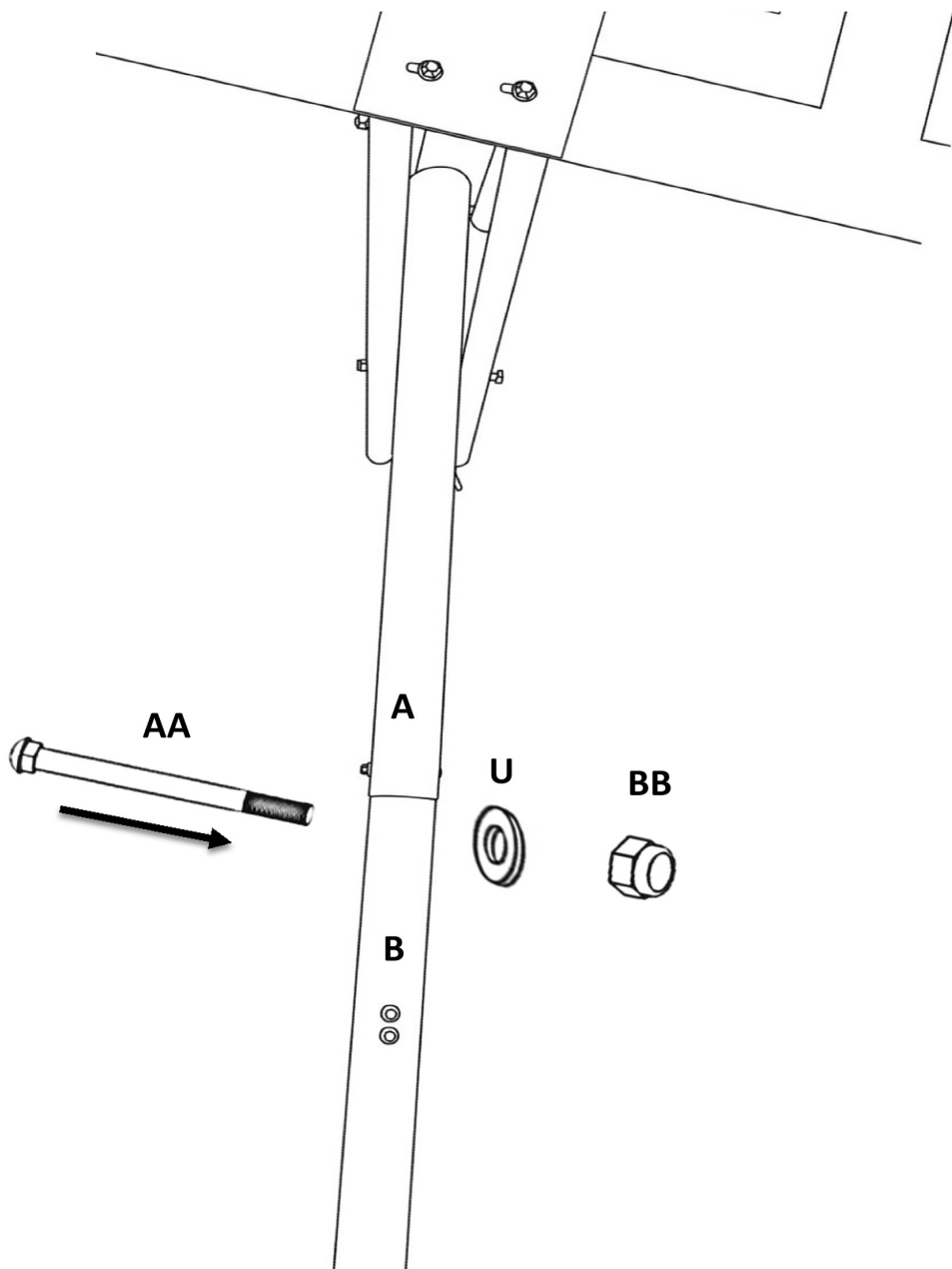

**ΒΗΜΑ 9: Μεσαίος και κάτω στύλος****GR**

#	Περιγραφή	Σχήμα
U	Ροδέλα 8,2x20x2mm (1 τμχ.)	
AA	Βίδα με στρογγυλό κεφάλι και τετράγωνο λαιμό 1/4"x87mm (1 τμχ.)	
BB	Παξιμάδι ασφαλείας 1/4" (1 τμχ.)	



**ΒΗΜΑ 10: Ένωση του ρυθμιστή ύψους με τον κάτω πίσω σωλήνα**

#	Περιγραφή	Σχήμα
X	Βίδα με εξάγωνο κεφάλι 3/8" x 165mm (1 τμχ.)	
Y	Παξιμάδι ασφαλείας 3/8" (1 τμχ.)	
P	Καπάκι ρυθμιστή ύψους Ø38,1mm (2 τμχ.)	
II	Πλαστικός σωλήνας 9,6x13x19mm (2 τμχ.)	
MM	Πλαστικό καπάκι για ρυθμιστή ύψους Ø25,4mm (1 τμχ.)	

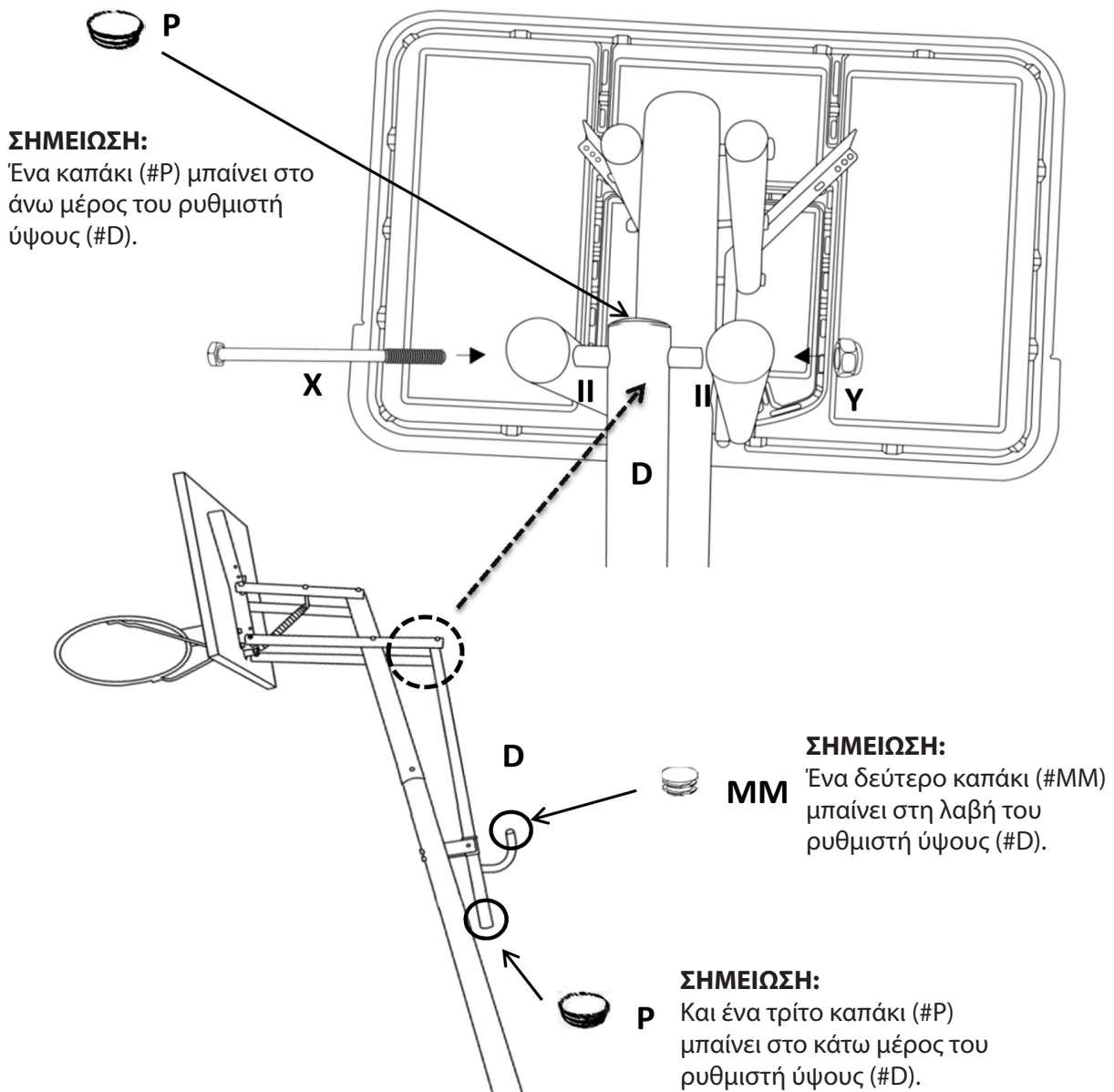

## ΒΗΜΑ 11: Πείρος ασφαλείας στο ρυθμιστή ύψους

GR



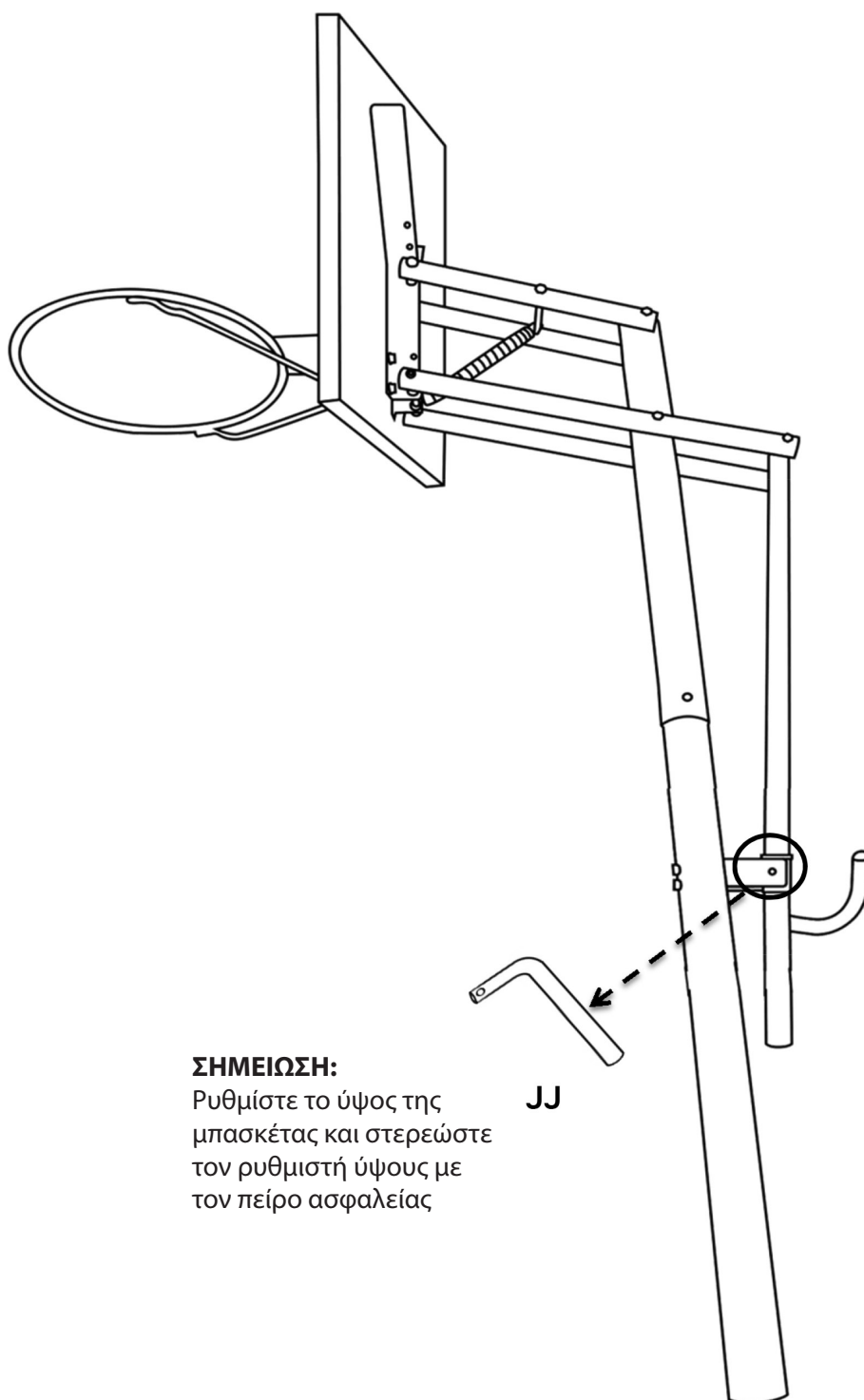

#	Περιγραφή	Σχήμα
JJ	Πείρος ασφαλείας (1 τμχ.)	



### ΣΗΜΕΙΩΣΗ:

Ρυθμίστε το ύψος της μπασκέτας και στερεώστε τον ρυθμιστή ύψους με τον πείρο ασφαλείας





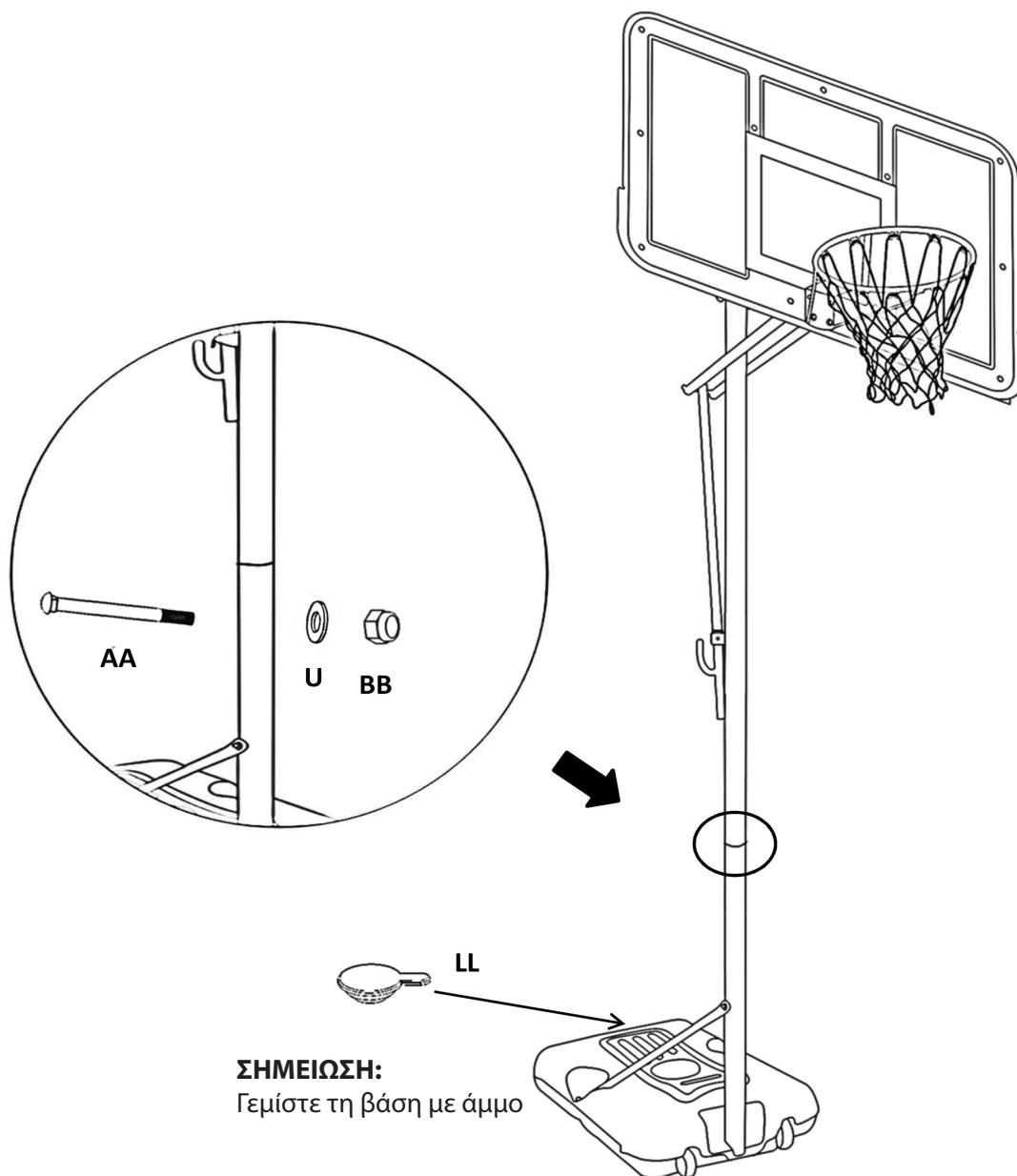





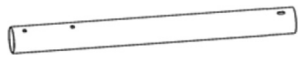
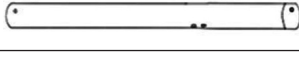
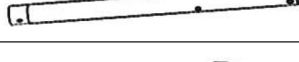
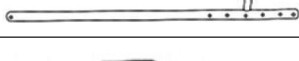

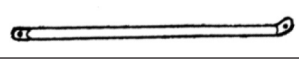

**ΒΗΜΑ 12: Ένωση μεσαίου με κάτω στύλο**

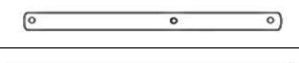
#	Περιγραφή	Σχήμα
AA	Βίδα με στρογγυλό κεφάλι και τετράγωνο λαιμό 1/4" x 87mm (1 τμχ.)	
BB	Παξιμάδι ασφαλείας 1/4" (1 τμχ.)	
U	Ροδέλα 8,2x20x2mm (1 τμχ.)	
LL	Καπάκι βάσης (1 τμχ.)	

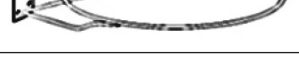





















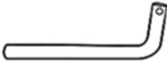

## PARTS LIST

#	Description	Drawing
A	Top pole Ø76,2x879mm (1 pc)	
B	Middle pole Ø76,2x1079mm (1 pc)	
C	Bottom pole Ø76,2x1079mm (1 pc)	
D	Height adjuster (1 pc)	
E	Base (1 pc)	
F	Left and right supports Ø25,4x835mm (2 pcs)	
G	Wheel (2 pcs)	
H	Axle Ø12x556mm (1 pc)	
I	Backboard (1 pc)	
J	"Y" shaped backboard frame (2 pcs)	
K	Back tube (upper) Ø38,1x480mm (2 pcs)	
L	Back tube (lower) Ø38,1x720mm (2 pcs)	
M	Rim Ø16mm (1 pc)	
N	Net (1 pc)	
O	Spring (1 pc)	
P	Handrail end cap Ø38,1mm (2 pcs)	
Q	Top pole cap (1 pc)	
R	Washer (for wheels) 13x25x2mm (4 pcs)	

EN

#	Description	Drawing
S	Hex bolts (for base) M8x25mm (2 pcs)	
T	Hex bolt M8x90mm (1 pc)	
U	Washer 8,2x20x2mm (18 pcs)	
V	Nylon hex nut M8 (9 pcs)	
W	Hex bolt (for backboard) M8x38mm (4 pcs)	
X	Hex bolt 3/8"x165mm (6 pcs)	
Y	Nylon hex nut 3/8" (6 pcs)	
Z	Hex head rod Ø9,2x142mm (1 pc)	
AA	Carriage bolt (round head, square neck) 1/4"x87mm (2 pcs)	
BB	Nylon hex nut 1/4" (2 pcs)	
CC	Truss head philips screw M8x35mm (2 pcs)	
DD	Flange nut M8 (2 pcs)	
EE	"U" plate (1 pc)	
FF	Hex screw (for "U" plate) M8x88mm (2 pcs)	
GG	Steel tube 10,5x12,7x42mm (2 pcs)	
HH	Plastic tube 13,2x16,8x15,6mm (4 pcs)	
II	Plastic tube 9,6x13x19mm (2 pcs)	
JJ	Lock pin (1 pc)	
KK	Hex head self-tapping screw 5/16"x6" (4 pcs)	
LL	Base cap (1 pc)	
MM	Plastic end-cap for height adjuster Ø25,4mm (1 pc)	

# ASSEMBLY INSTRUCTIONS



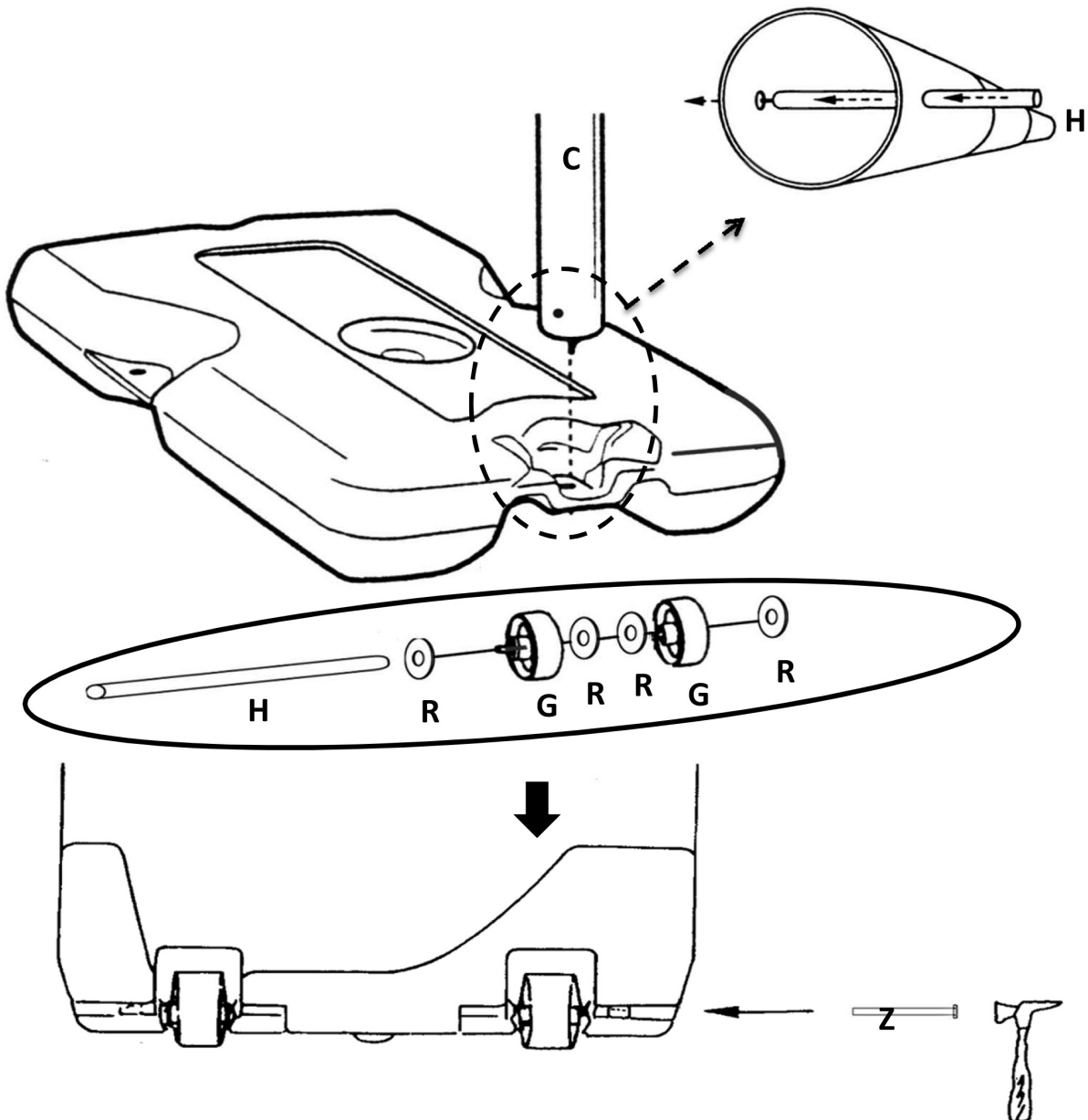

## Step 1: Base

#	Description	Drawing
C	Bottom pole $\text{Ø}76,2 \times 1079 \text{mm}$ (1 pc)	
E	Base (1 pc)	
G	Wheel (2 pcs)	
H	Axle $\text{Ø}12 \times 556 \text{mm}$ (1 pc)	
R	Washer (for wheels) $13 \times 25 \times 2 \text{mm}$ (4 pcs)	
Z	Hex head rod $\text{Ø}9,2 \times 142 \text{mm}$ (1 pc)	

EN





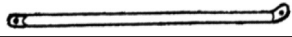

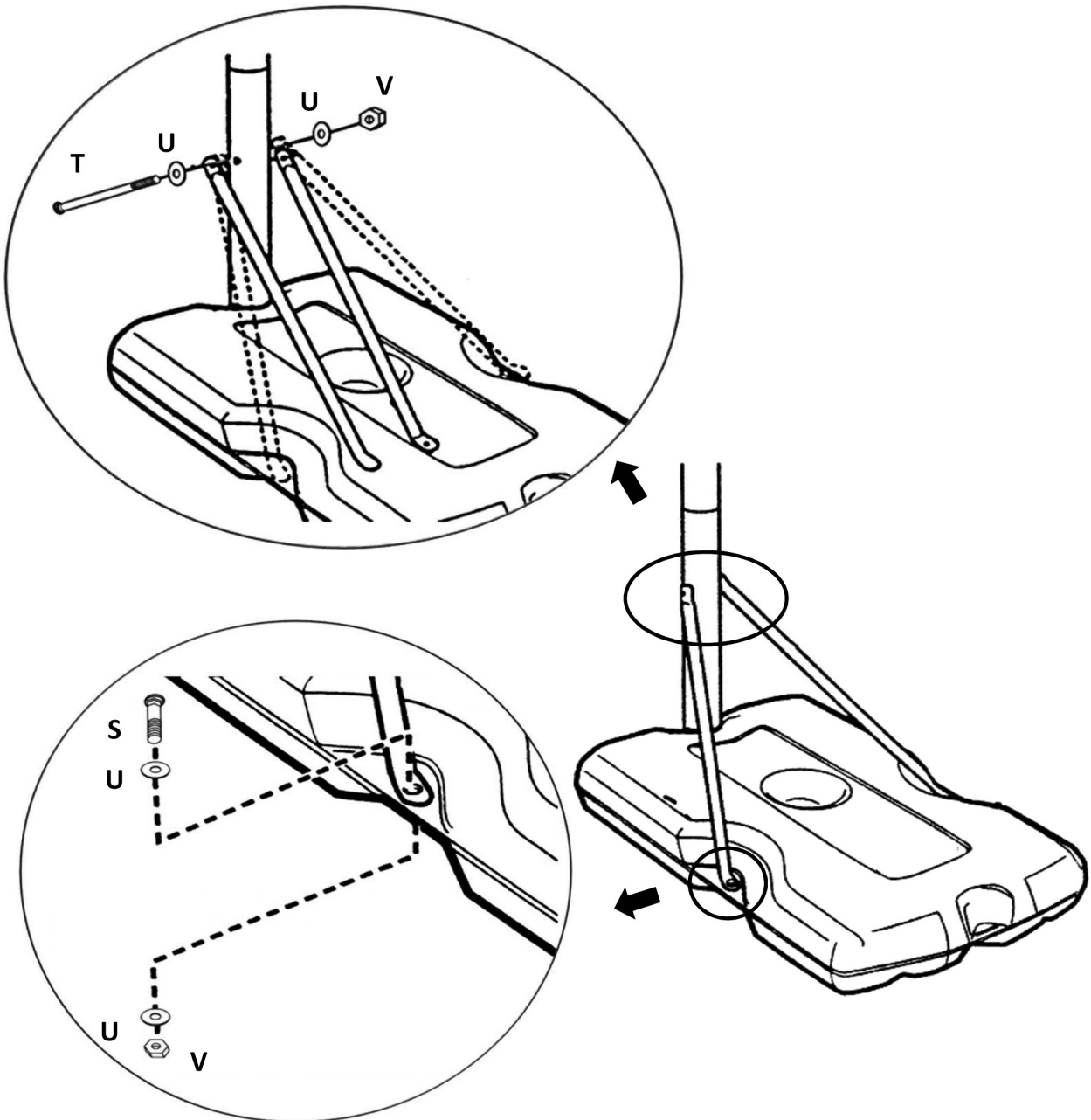
**Step 2: Lower pole and supports**

#	Description	Drawing
T	Hex bolt M8x90mm (1 pc)	
U	Washer 8,2x20x2mm (6 pcs)	
V	Nylon hex nut M8 (3 pcs)	
S	Hex bolts (for base) M8x25mm (2 pcs)	
F	Left and right supports Ø25,4x835mm (2 pcs)	



### Step 3: Backboard frame



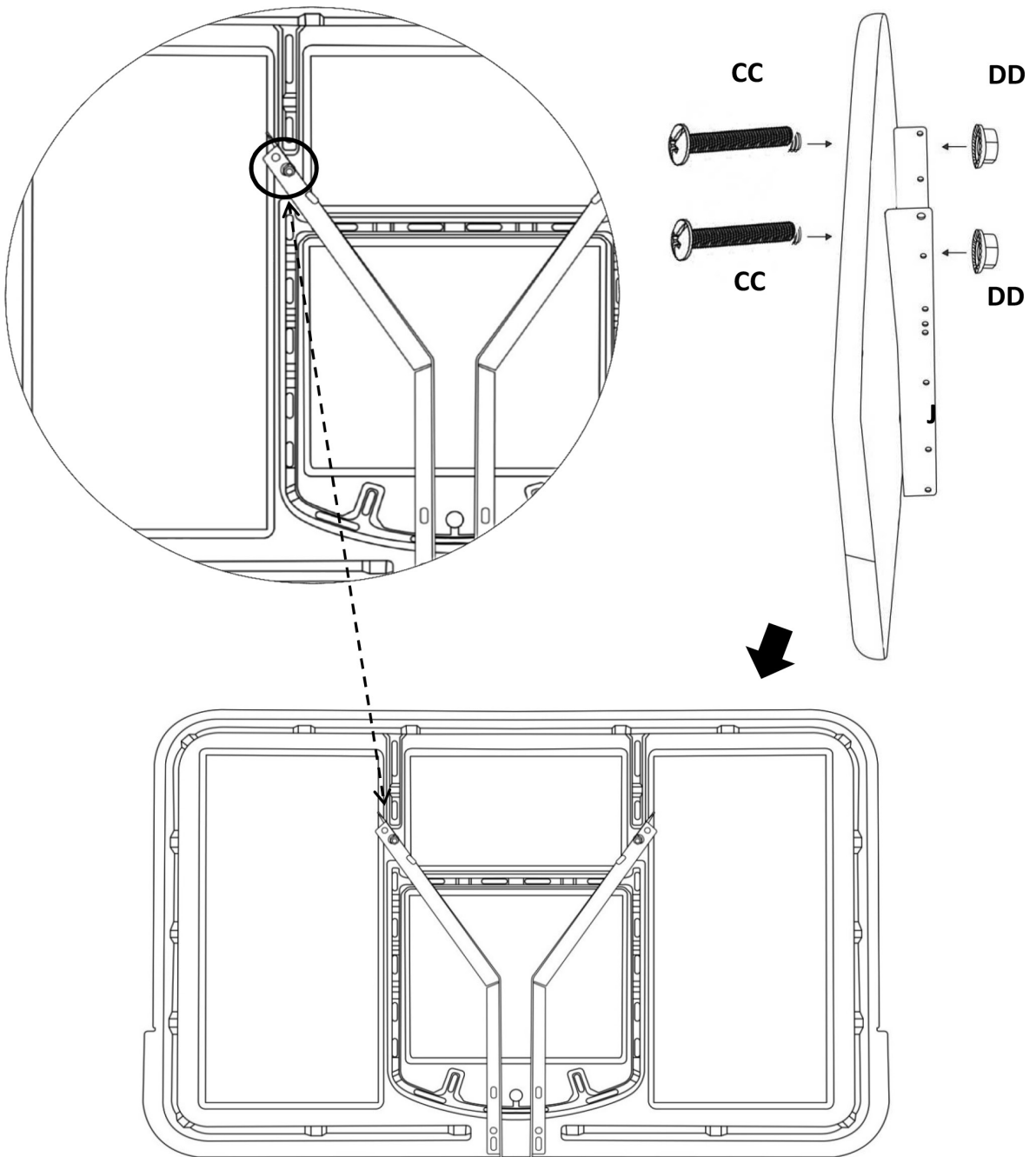

#	Description	Drawing
I	Backboard (1 pc)	
J	"Y" shaped backboard frame (2 pcs)	
CC	Truss head philips screw M8x35mm (2 pcs)	
DD	Flange nut M8 (2 pcs)	

EN



## Step 4: Rim

EN

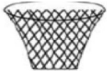
#	Description	Drawing
U	Washer 8,2x20x2mm (8 pcs)	
V	Nylon hex nut M8 (4 pcs)	
W	Hex bolt (for backboard) M8x38mm (4 pcs)	
M	Rim Ø16mm (1 pc)	
N	Net (1 pc)	

**NOTE:**



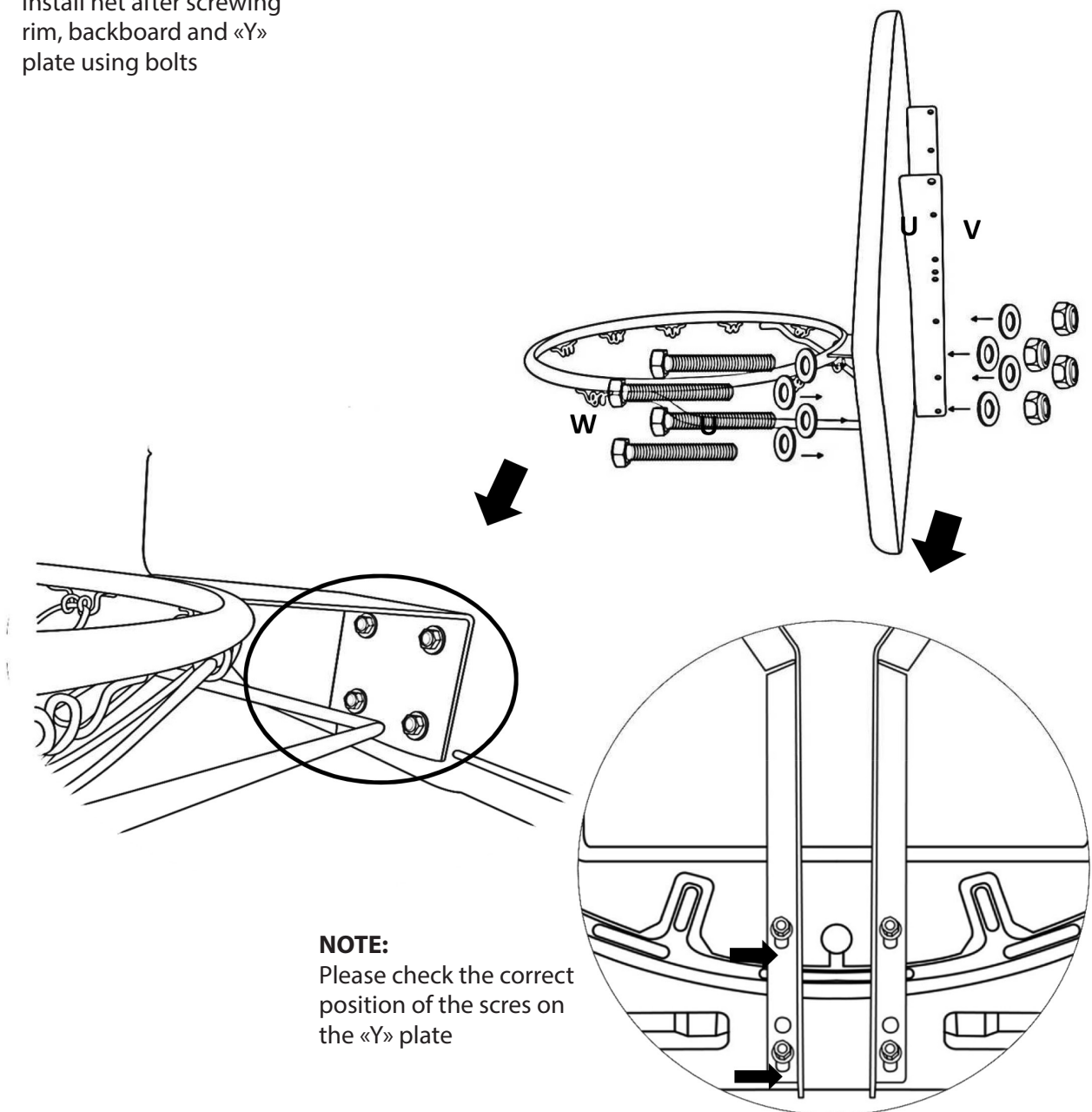



Install net after screwing rim, backboard and «Y» plate using bolts



**NOTE:**

Please check the correct position of the screws on the «Y» plate

### Step 5-1: Back pipes (1/2)

#	Description	Drawing
K	Back tube (upper) Ø38,1x480mm (2 pcs)	
L	Back tube (lower) Ø38,1x720mm (2 pcs)	
X	Hex bolt 3/8"x165mm (2 pcs)	
Y	Nylon hex nut 3/8" (2 pcs)	
GG	Steel tube 10,5x12,7x42mm (2 pcs)	
HH	Plastic tube 13,2x16,8x15,6mm (4 pcs)	

**NOTE:**  
The end of the back pipes with the larger spacing of the holes is the one assembled with the «Y» plates

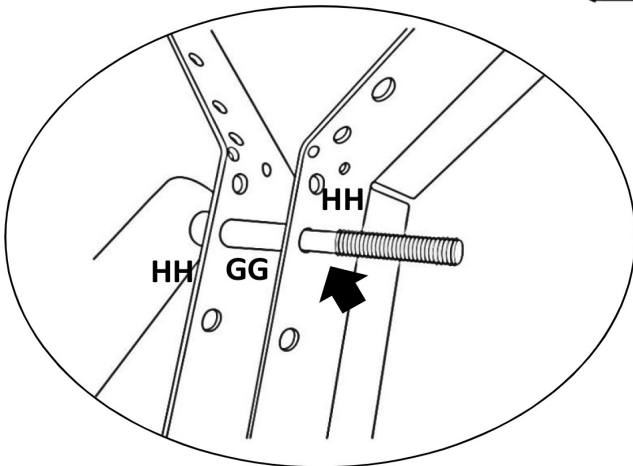
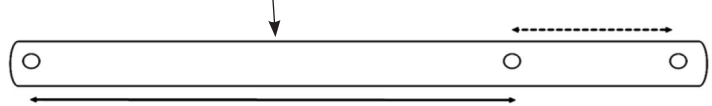

**NOTE:**  
Take care to place the tubes (GG & HH) at the correct position

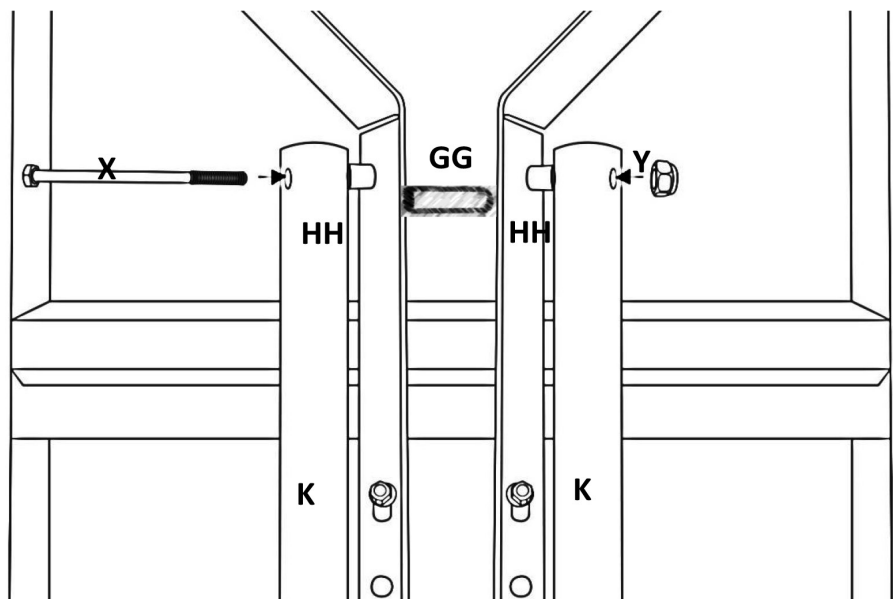

## Step 5-2: Back pipes (2/2)

EN

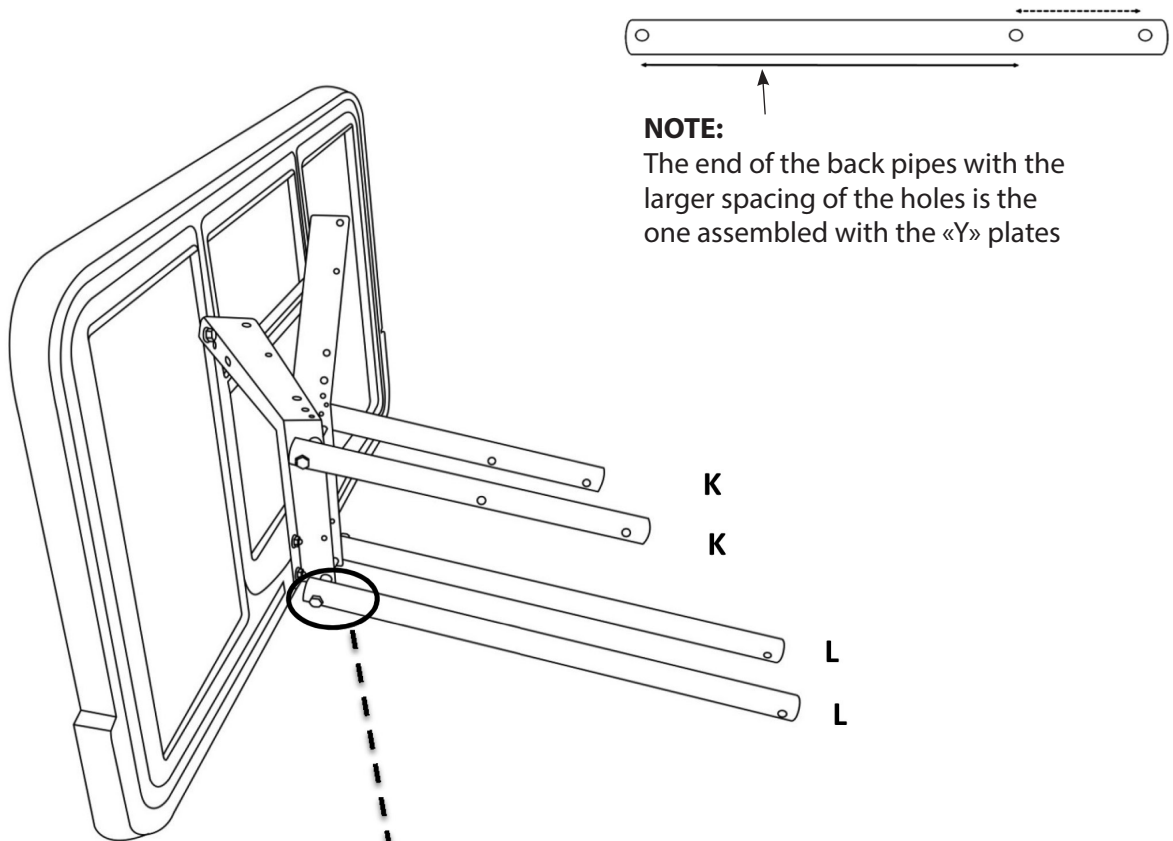

**NOTE:**  
The end of the back pipes with the larger spacing of the holes is the one assembled with the «Y» plates



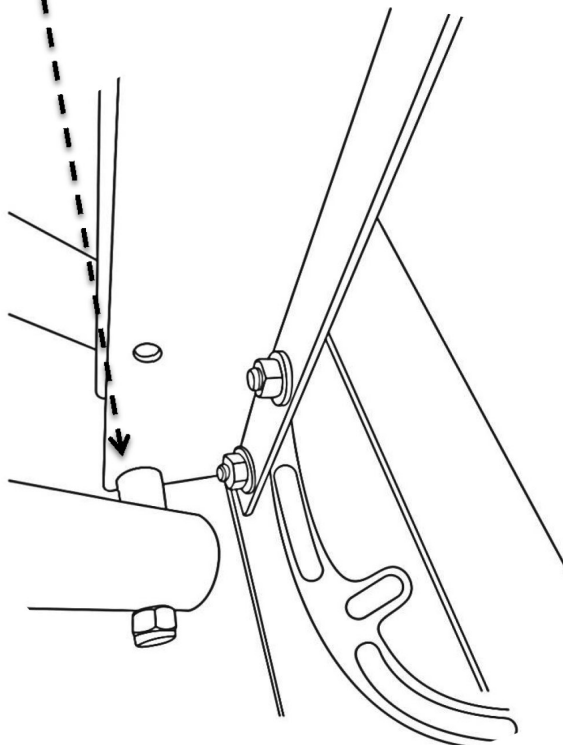

**NOTE:**  
Please use the lowest hole of the «Y» plates

**NOTE:**  
The screw, nuts and tubes are the same as the previous step's on the bottom of the previous page



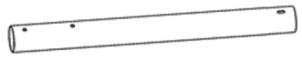

**Step 6: Backboard and top pole**

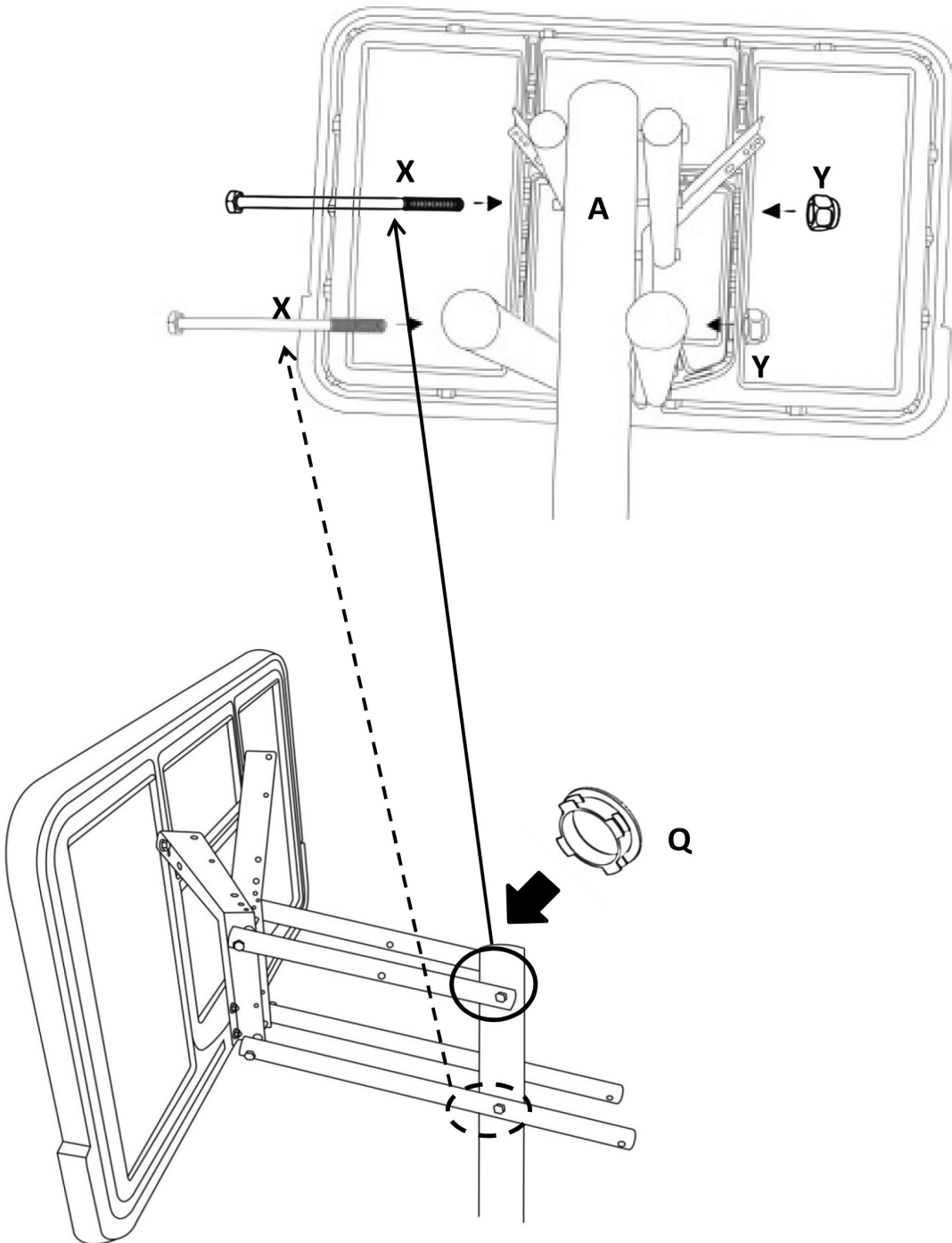

#	Description	Drawing
A	Top pole Ø76,2x879mm (1 pc)	
X	Hex bolt 3/8"x165mm (2 pcs)	
Y	Nylon hex nut 3/8" (2 pcs)	
Q	Top pole cap (1 pc)	

**EN**







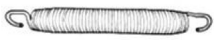

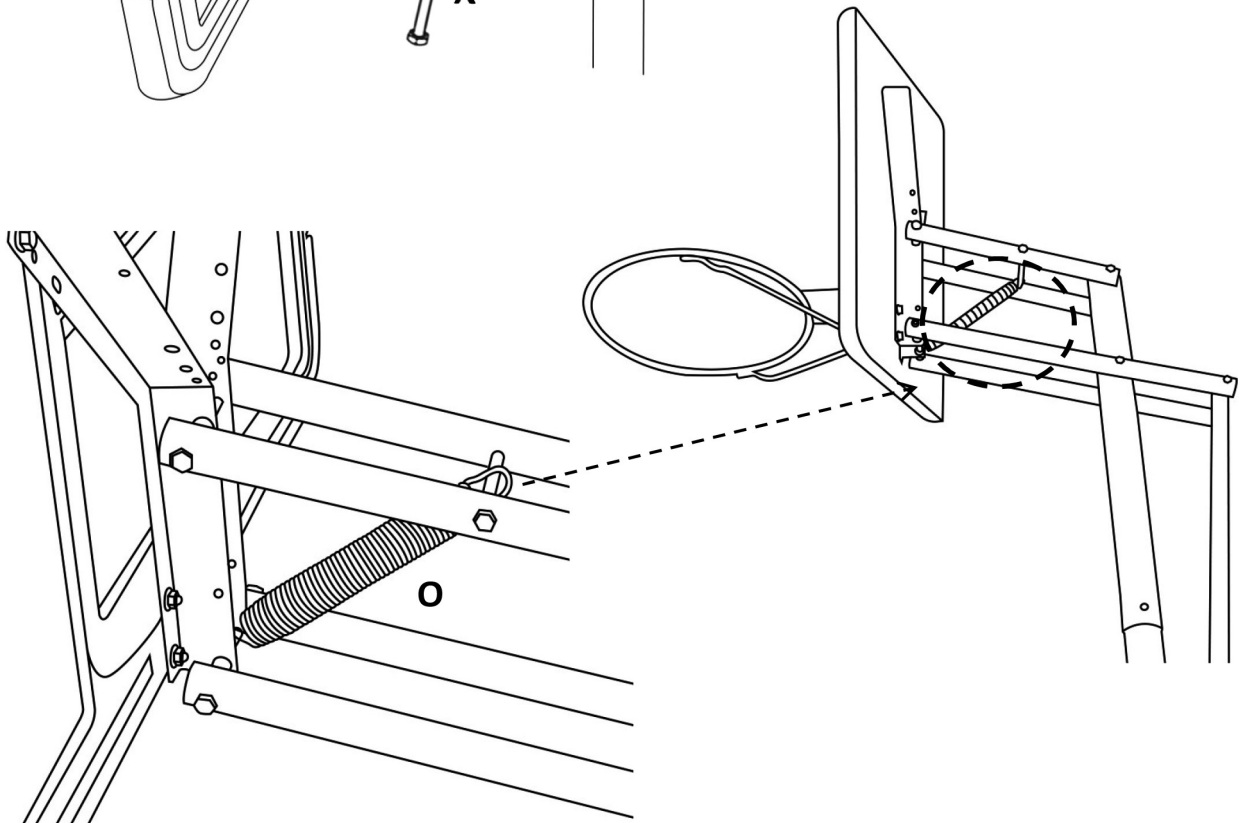
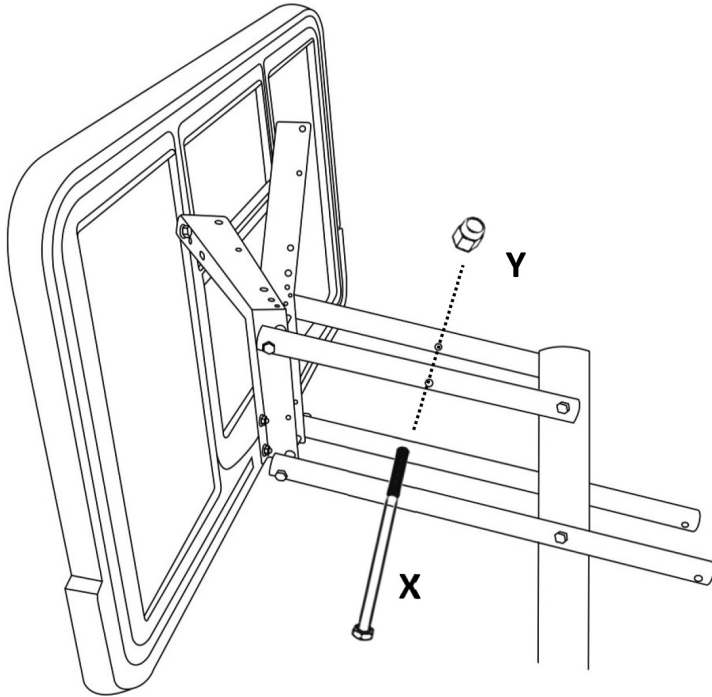
### Step 7: Spring behind the backboard

EN

#	Description	Drawing
X	Hex bolt 3/8"x165mm (1 pc)	
Y	Nylon hex nut 3/8" (1 pc)	
O	Spring (1 pc)	



### Step 8: Height adjuster on middle pole

#	Description	Drawing
B	Middle pole Ø76,2x1079mm (1 pc)	
D	Height adjuster (1 pc)	
U	Washer 8,2x20x2mm (2 pcs)	
V	Nylon hex nut M8 (2 pcs)	
EE	“U” plate (1 pc)	
FF	Hex screw (for “U” plate) M8x88mm (2 pcs)	

EN

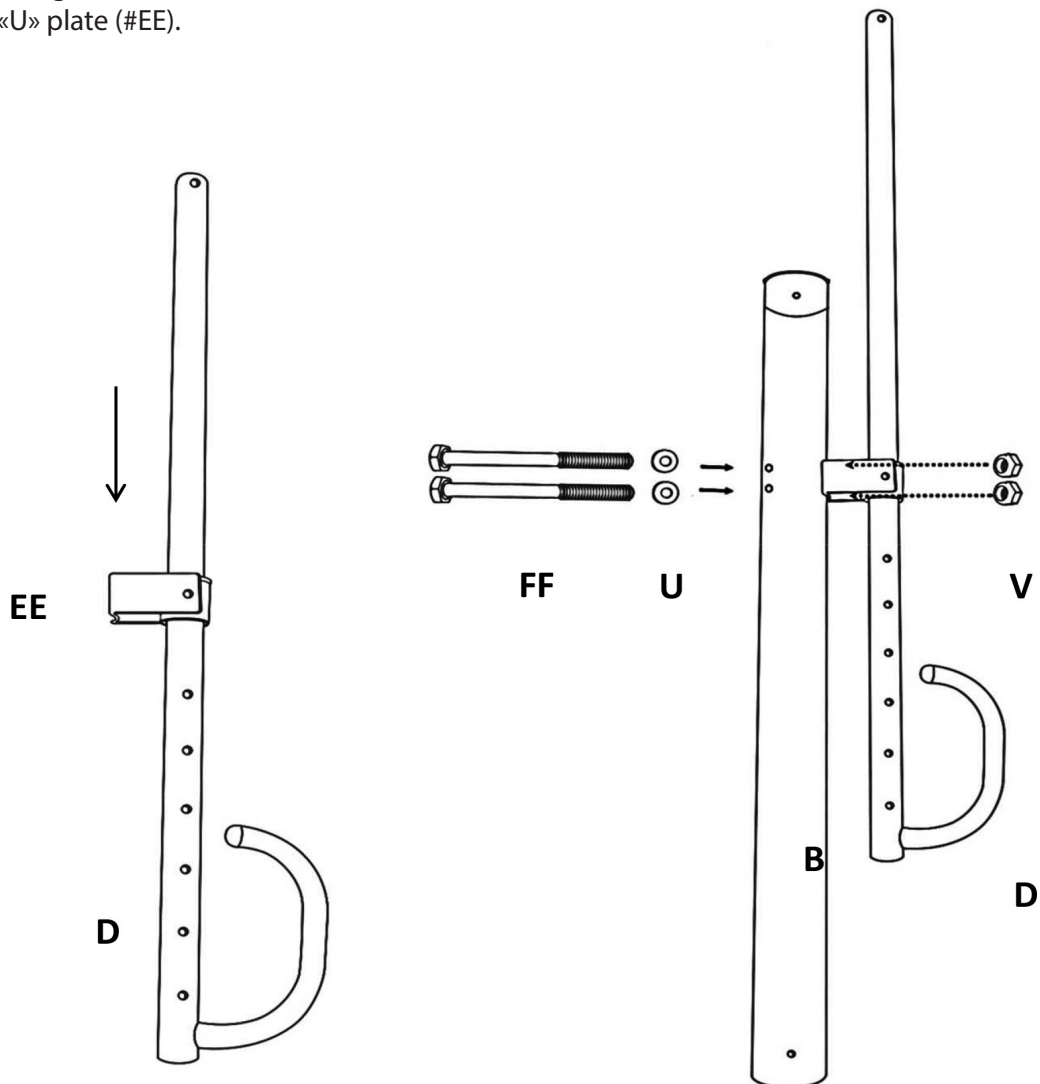

**NOTE:**

The height adjuster (#D) goes through the hole of the «U» plate (#EE).





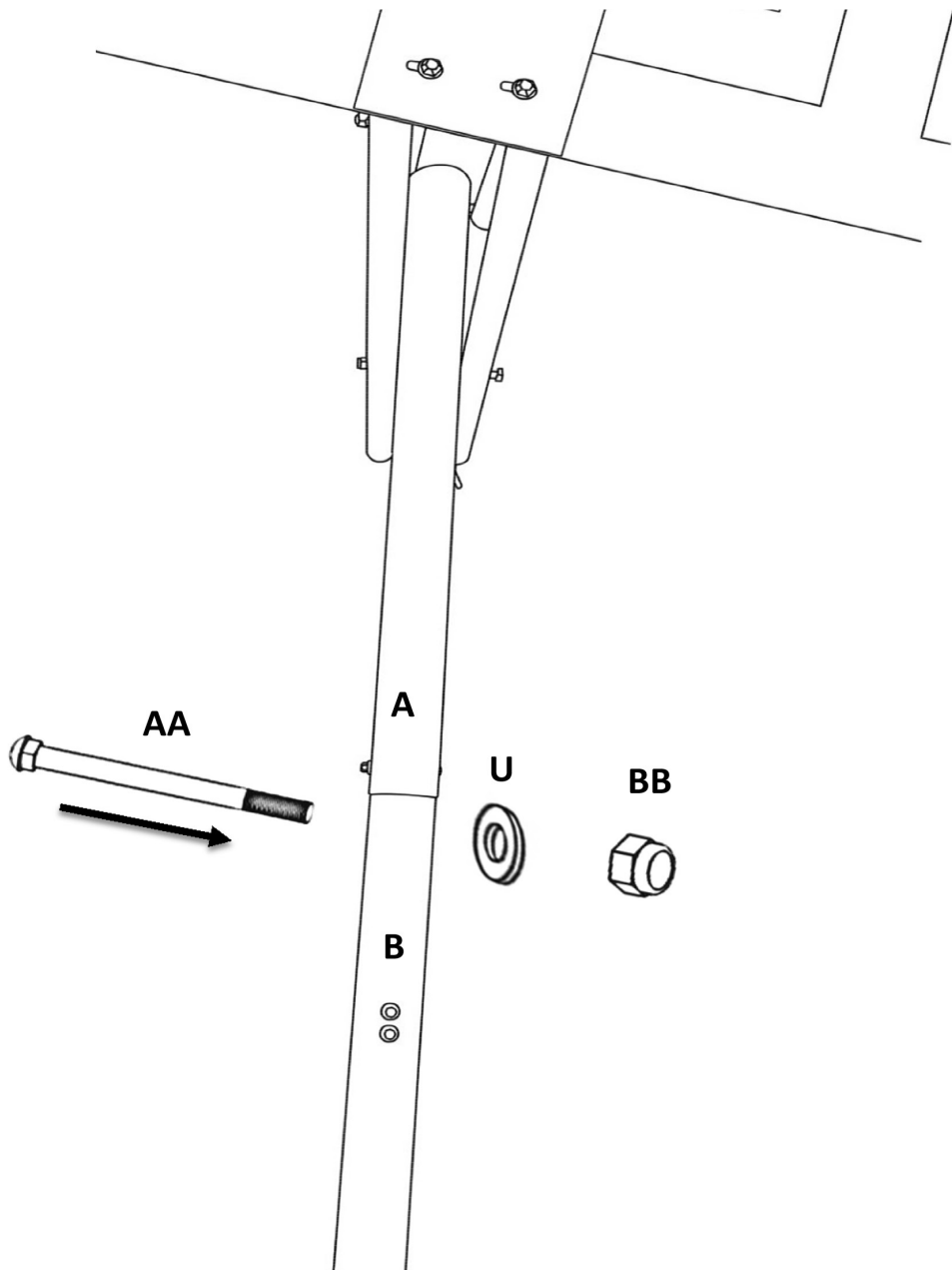

**Step 9: Midle and bottom pole**

**EN**

#	Description	Drawing
U	Washer 8,2x20x2mm (1 pc)	
AA	Carriage bolt (round head, square neck) 1/4"x87mm (1 pc)	
BB	Nylon hex nut 1/4" (1 pc)	



**Step 10: Connect the height adjuster to the lower back tube**

#	Description	Drawing
X	Hex bolt 3/8"x165mm (1 pc)	
Y	Nylon hex nut 3/8" (1 pc)	
P	Handrail end cap Ø38,1mm (2 pcs)	
II	Plastic tube 9,6x13x19mm (2 pcs)	
MM	Plastic end-cap for height adjuster Ø25,4mm (1 pc)	

**EN**

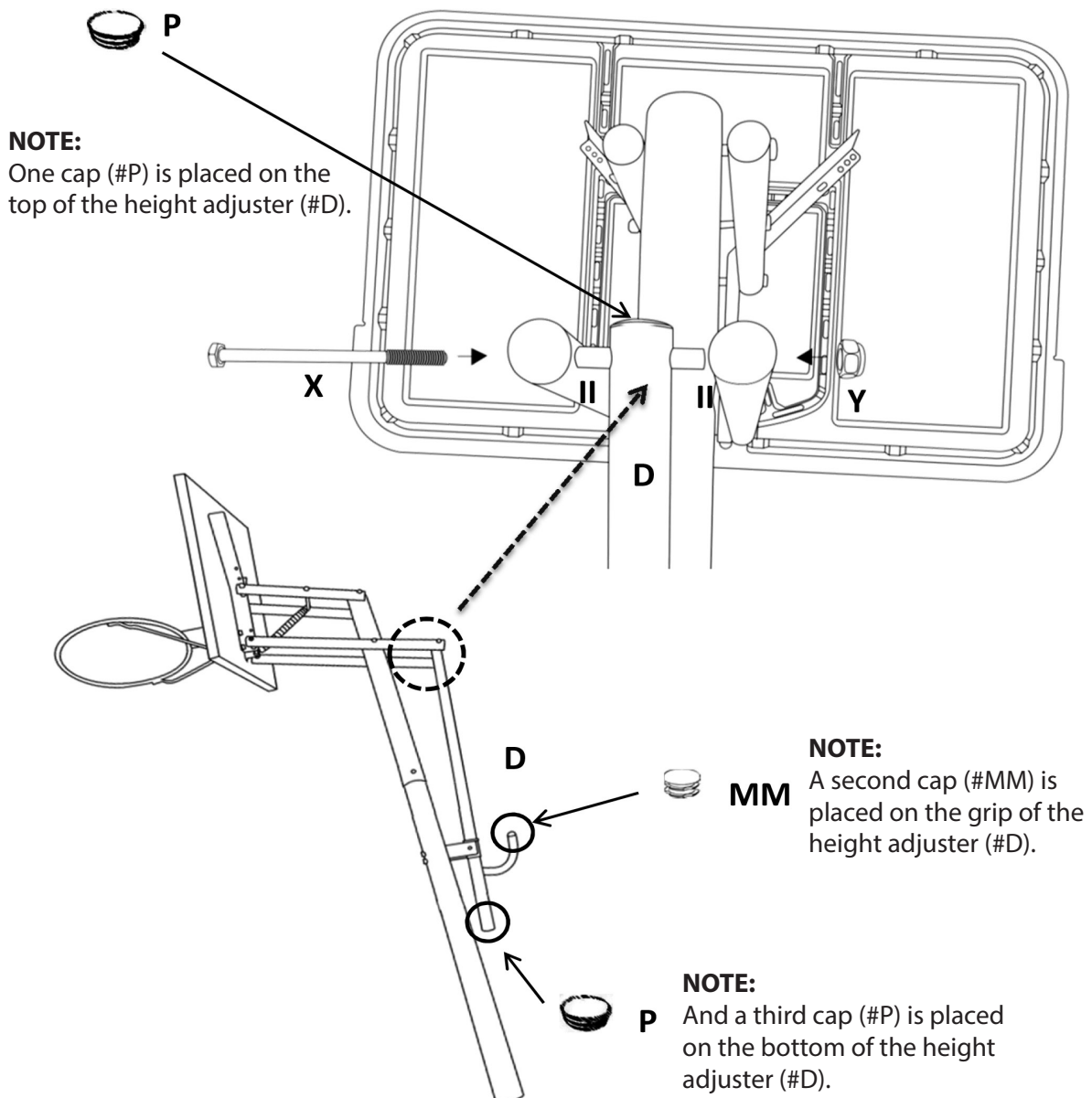



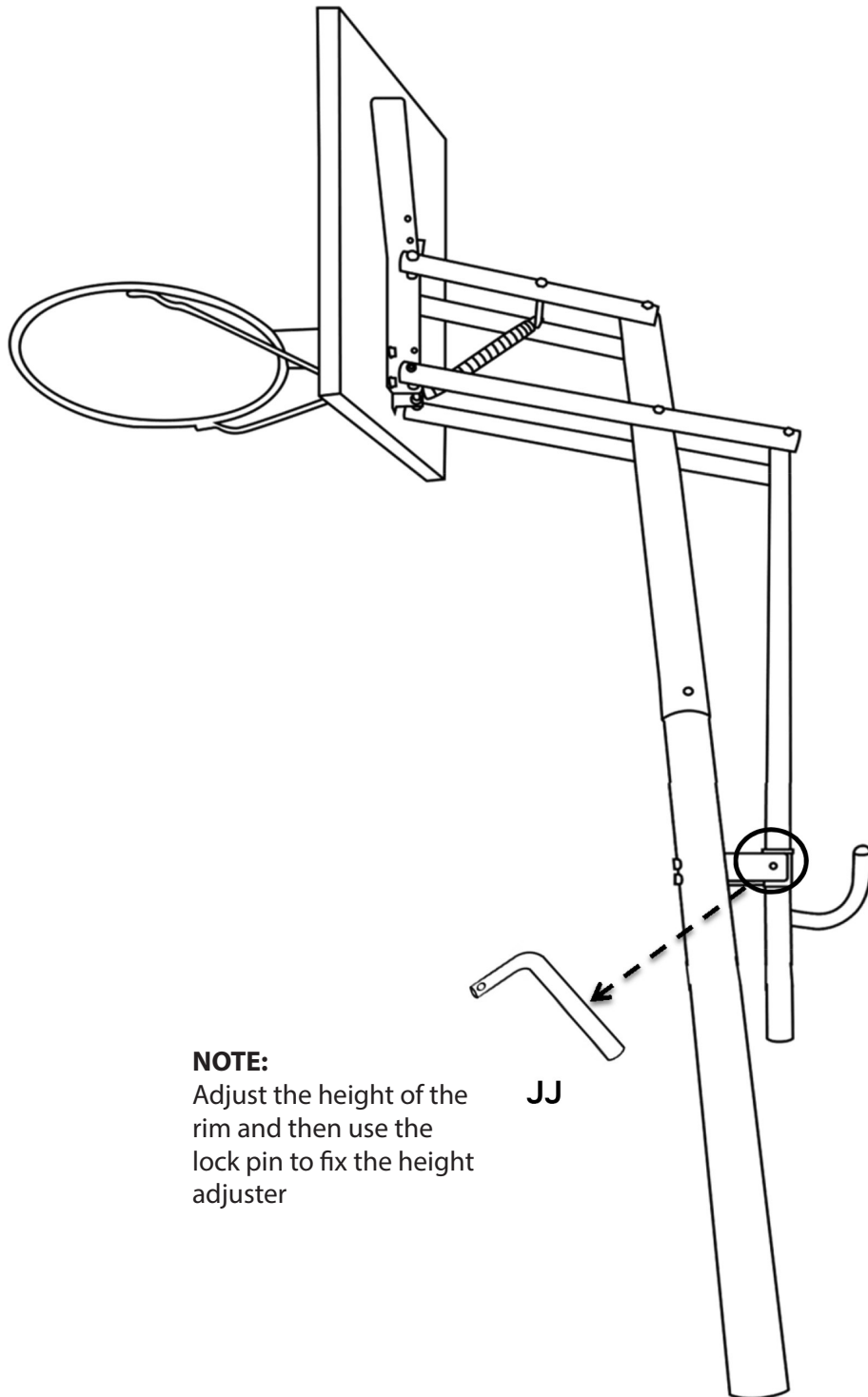

**Step 11: Lock pin on the height adjuster**

EN

#	Description	Drawing
JJ	Lock pin (1 pc)	



## Step 12: Middle and bottom pole

#	Description	Drawing
AA	Carriage bolt (round head, square neck) 1/4"x87mm (1 pc)	
BB	Nylon hex nut 1/4" (1 pc)	
U	Washer 8,2x20x2mm (1 pc)	
LL	Base cap (1 pc)	

EN

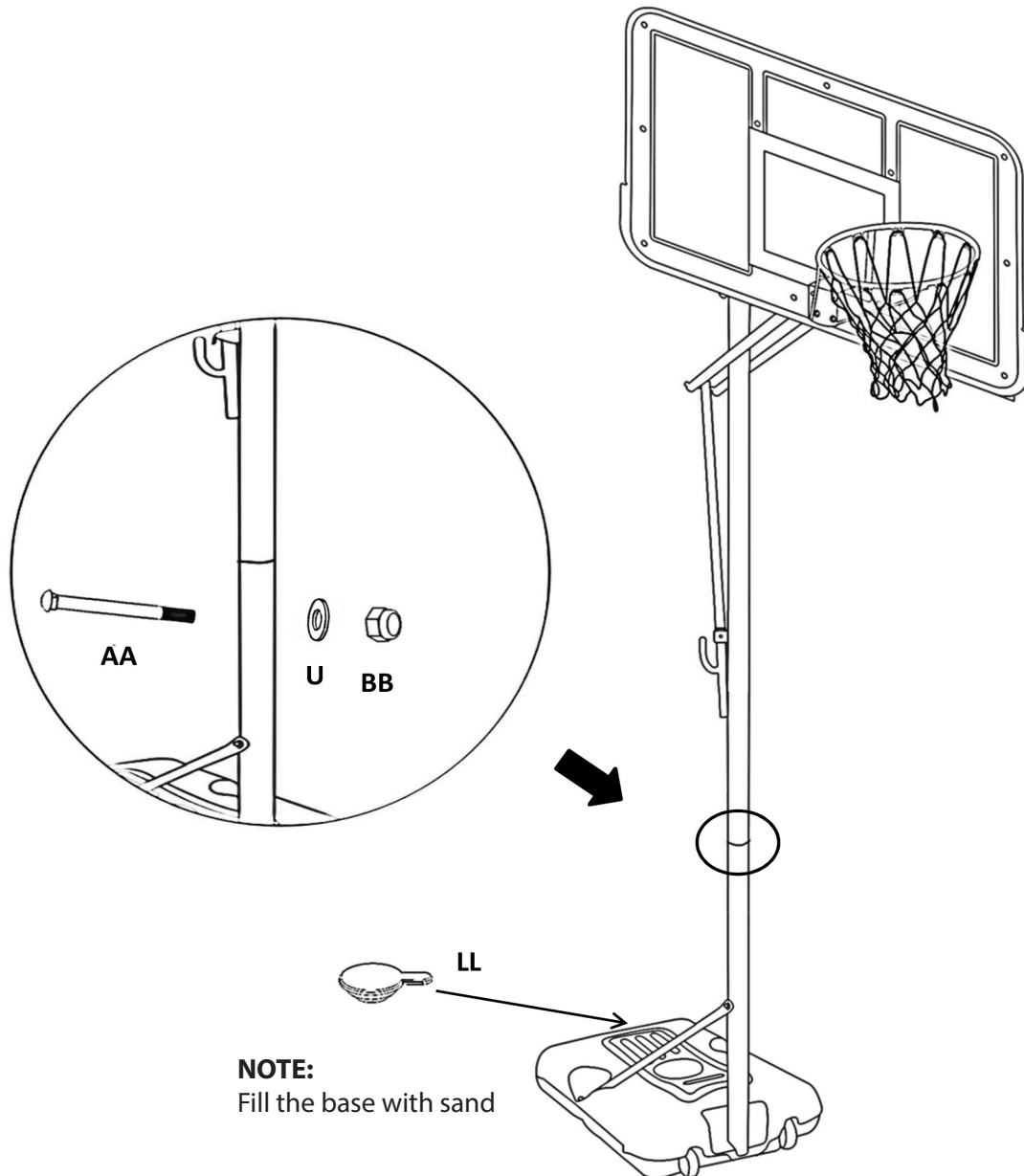



Διανέμεται από την **ΕΛΔΙΚΟ ΣΠΟΡ ΜΟΝ. Α.Ε.Ε.**

Distributed by **ELDICO SPORT SA**

eMail: [support@eldico.gr](mailto:support@eldico.gr) • Web Site: [eldico.gr](http://eldico.gr)