

SPIRIT



CE800 Elliptical OWNER'S MANUAL

Please carefully read this entire manual before operating your new elliptical.

Table of Contents

Important Safety Instructions.....	2
Important Operation Instructions.....	3
Features.....	3
Assembly Instructions.....	6
Getting On / Off Your Elliptical.....	10
Console Operation.....	12
Maintenance.....	26
Exploded View Diagram and Parts List.....	27

Important Safety Instructions

WARNING - Read all instructions before using this exercise equipment.

WARNING - Heart rate monitoring systems may be inaccurate. Over exercising may result in serious injury or death. If you feel faint stop exercising immediately.

- Do not operate elliptical on deeply padded, plush or shag carpet. Damage to both carpet and elliptical may result.
- Keep children away from the elliptical. There are obvious pinch points and other caution areas that can cause harm.
- Keep hands away from all moving parts.
- Never drop or insert any object into any openings.
- Do not use outdoors.
- Do not attempt to use your elliptical for any purpose other than for the purpose it is intended.
- The hand pulse sensors are not medical devices. Various factors, including the user's movement, may affect the accuracy of heart rate readings. The pulse sensors are intended only as exercise aids in determining heart rate trends in general.
- Wear proper shoes. High heels, dress shoes, sandals or bare feet are not suitable for use on your elliptical. Quality athletic shoes are recommended to avoid leg fatigue.
- This exercise equipment can be used by children aged from 8 years and above and persons with reduced physical, sensory or mental capabilities or lack of experience and knowledge if they have been given supervision or instruction concerning use of the exercise equipment in a safe way and understand the hazards involved. Children shall not play with the exercise equipment. Cleaning and user maintenance shall not be made by children without supervision.
- Children should be supervised to ensure that they do not play with the exercise equipment.
- Be aware that the generator is producing AC power while the elliptical is being used. Do not service the elliptical while the generator is spinning; serious electric shock could occur.
- "WARNING! Heart rate monitoring systems may be inaccurate. Over exercising may result in serious injury or death. If you feel faint stop exercising immediately".
- Any changes or modifications not expressly approved by the grantee of this device could void the user's authority to operate the equipment.
- This exercise equipment is not intended for use by persons (including children) with reduced physical, sensory or mental capabilities, or lack of experience and knowledge, unless they have been given supervision or instruction concerning use of the exercise equipment by a person responsible for their safety.
- Before beginning this or any exercise program, consult a physician. This is especially important for persons over the age of 35 or persons with pre-existing health conditions.
- Close supervision is necessary when this exercise equipment is used by, on, or near children, invalids, or disabled persons.
- The elliptical trainer is not equipped with a free wheel and therefore the moving parts cannot be stopped immediately.
- The individual human power which is required to carry out an exercise can be different than the mechanical power displayed.

Max. user's weight.: 150 kg

SAVE THESE INSTRUCTIONS - THINK SAFETY!

Important Electrical Instructions

WARNING!

NEVER expose this elliptical to rain or moisture. This product is **NOT** designed for use outdoors, near a pool or spa, or in any other high humidity environment. The operating temperature specification is 5 to 48 degrees Celsius (40 to 120 degrees Fahrenheit), and humidity is 95 non-condensing (no water drops forming on surfaces).

Important Operation Instructions

- **NEVER** operate this elliptical without reading and completely understanding the results of any operational change you request from the computer.
- **All users** should have medical clearance before starting any rigorous exercise program. This is especially important for persons with a history of heart disease or other high risk factors.
- Understand that changes in resistance do not occur immediately. Set your desired resistance level on the computer console and release the adjustment key. The computer will obey the command gradually.
- Use caution while participating in other activities while pedaling on your elliptical; such as watching television, reading, etc. These distractions may cause you to lose balance which may result in serious injury.
- Do not use excessive pressure on console control keys. They are precision set to function properly with little finger pressure.
- This equipment has a speed-dependent braking system, i.e. the faster you stride, the higher the load at the pedals.

The Elliptical has a constant power program that simulates a speed-independent braking system, i.e. independently as fast you can stride the load always remains the same.

- Always hold on to a handle bar while making control changes.
- Do not use excessive pressure on console control keys. They are precision set to function properly with little finger pressure. If you feel the buttons are not functioning properly with normal pressure contact your dealer.

Features

Footpads

- Through research performed with a leading sports scientist and a physical rehabilitation expert, the engineering team has developed a breakthrough in pedal design. The history of elliptical use over the past few years tells us that many users suffer from ankle, Achilles tendon, knee and/or hip pain.
- While researching a solution to these common problems the engineers consulted Richard DeKok, P.T., M.T.C., of St. Bernards Industrial Rehabilitation Center in Jonesboro Arkansas. Together we identified the inherent problem in elliptical designs and developed a solution to solve the problem. What we found is that when you use an elliptical you tend to push outward during the power stroke and not just straight back. This causes stress on the outer part of the foot and throws off the natural alignment of the body's joints. The solution we discovered was to add a 2-degree inward angle to the footpads. This might sound simple but it was all that was needed to put the user's joints back into a neutral alignment. This eases the over stressing of the ankles, knees and hips and allows the user to exercise longer without discomfort.

Assembly Pack Check List

Step1

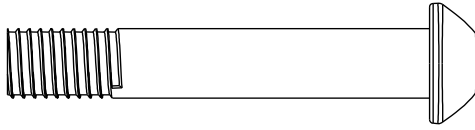

#106 - 3/8" x 2-1/4"
Stainless Steel Bolt (4 pcs)

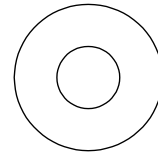

#109 - 3/8"
Flat Washer (4 pcs)

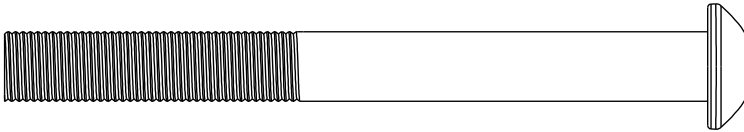

#107 - 3/8" x 3-3/4" Stainless Steel Bolt (6 pcs)

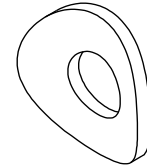

#108 - 3/8"
Curved Washer (6 pcs)

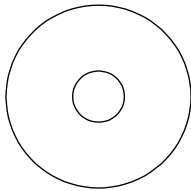

#87 - 5/16"
Flat Washer (2 pcs)

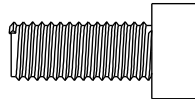

#97 - 5/16" x 15mm
Bolt W / Loctite (2 pcs)

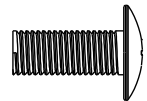

#103 - M6 x 15mm
Phillips Head Screw (2 pcs)

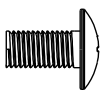

#110 - M5 x 10mm
Phillips Head Screw
W / Loctite (8 pcs)

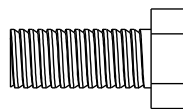

#76 - 5/16" x 3/4"
Hex head bolt (4 pcs)

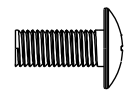

#78 - M5 x 12mm
Phillips Head Screw (14 pcs)

Step2

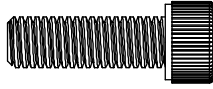

#75 - M8 x 25mm
Socket Cap Bolt (4 pcs)

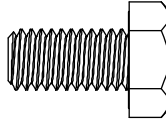

#117 - 3/8" x 3/4"
Hex Head Bolt
W / Loctite (2 pcs)

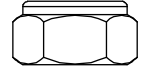

#118 - M10
Nylon Nut (2 pcs)

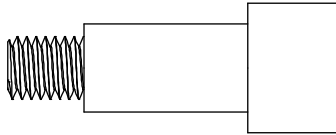

#119 - M10 x 38mm
Shoulder Bolt (2 pcs)

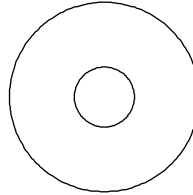

#120 - 3/8"
Flat Washer (2 pcs)



#113 - 3.5mm x 12mm
Sheet Metal Screw (4 pcs)



#90 - 25mm
Wave Washer (2 pcs)

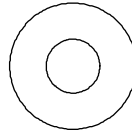

#88 - 5/16"
Flat Washer (1 pcs)

Step3



#113 - 3.5 x 12mm
Sheet Metal Screw (14 pcs)



#78 - M5 x 12mm
Phillips Head Screw (14 pcs)

Assembly Instructions

STEP 1: Rear Rail and Pedal Arm Assembly

- Slide the rail assembly (2) under the rear oval stabilizer tube of the main body. Bolt the two together with two 3/8" x 2-1/4" bolts (106) and 3/8" washers (109) from the top of the tube, and four 3/8" x 3-3/4" bolts (107) and 3/8" curved washers (108) through the front of the oval stabilizer. Make sure all six bolts are tightened very securely.
- Attach the two footpads (48 left & 49 right) to the pedal mounting plates with eight M5 x 10mm screws (110).
- Assemble the pedal arm assemblies (5 & 6) to the crank axles of the main body. The bearings in the pedal arms should slide onto the axles, do not force them because damage to the bearings can occur. The pedal arms have been previously assembled at the factory to assure the correct fit. Secure the pedal arms with two 5/16" x 15mm bolts (97) and 5/16" washers (87).
- Install the two covers (45 right, 46 left) over the pedal arm connection at the axle with two M6 x 15mm screws (103). Install the two wheel covers (50) with four M5 x 12mm screws (78).
- Install the four mounting brackets (17) and (26) to the rails with four 5/16" x 3/4" bolts (76). Install the two steel covers (15 right & 16 left) by lifting the pedal arms so the wheels are off the tracks then slide the pedal arms, wheels first, through the opening of the steel cover. Align the cover with the mounting brackets and secure them with eight M5 x 12 mm screws (78). Install the four small covers (2 x #19 & 2 x #20) with ten M5 x 12mm screws (78).
- Install the center aluminium step rail (72) with two 3/8" x 3-3/4" bolts (107) and curved washers (108) at the rear and two 3/8" x 2-1/4" bolts (106) and flat washers (109) at the front. Install the two stabilizer tube covers (64 left & 65 right) with two M5 x 12mm screws (78).

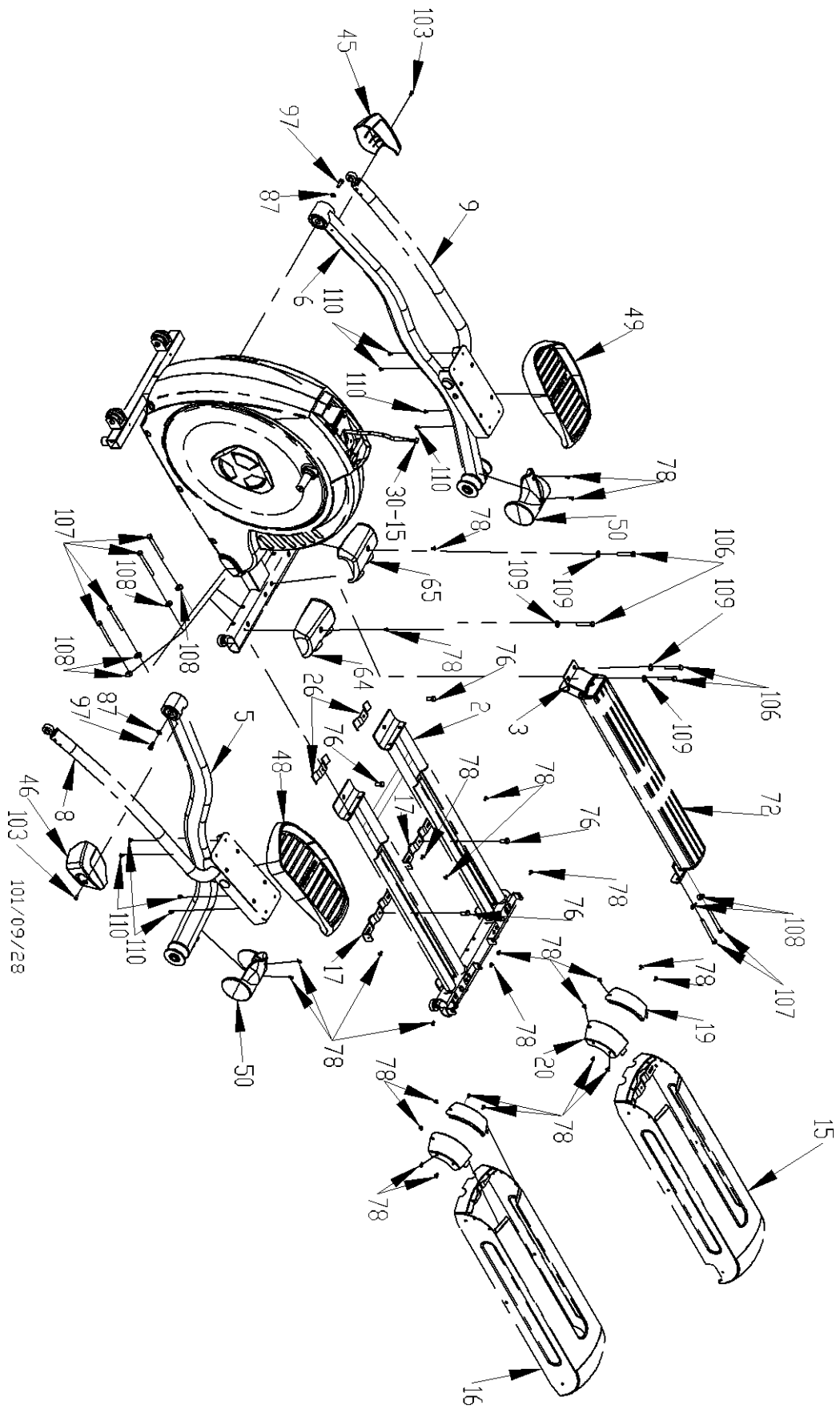

101/09/28

STEP 2: Console Mast and Swing Arms

- Unravel the computer cable (30-15) and snake it through the bottom of the console mast (12) and out the top. **To install mast tube (12), first insert three M8x25mm screws (75) onto the mainframe then locate the mast tube (12) on its position and tighten three screws. Now the last M8x25mm screw (75) must be with 5/16" flat washer (88) to tighten to the screw hole.**
- Mount the console mast covers (61 left & 62 right) and secure with four 3.5mm x 12mm screws (113).
- Install two wave washers (90) onto the console mast axle then install the swing arms (10 left & 11 right) onto the axles. Do not force them or use a hammer as damage to the bearings can occur. The swing arms have been previously assembled at the factory to assure the correct fit. Secure the arms with two 3/8" x 3/4" bolts (117) and 3/8" flat washers (120). Attach the bottom of the swing arms to the rod ends of the pedal arms using two M10 x 38mm shoulder bolts (119) and M10 nylon nuts (118).

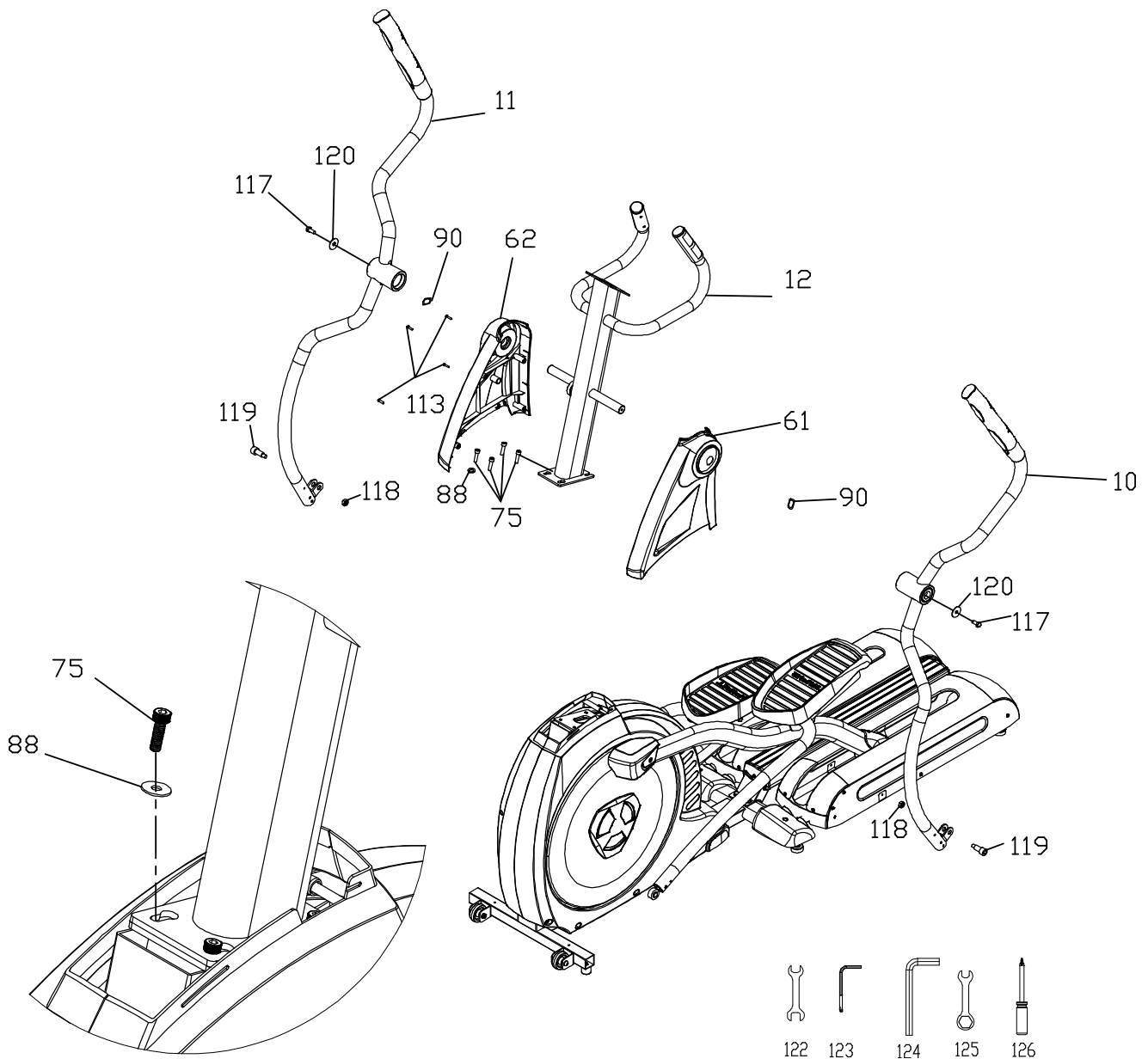

STEP 3: Console and Beauty Covers

- Plug the computer cable (30-15) and hand pulse cables (35 x 2) into the corresponding connectors on the back of the console (30). Mount the console on the mast with four M5 x 12mm screws (78).
- Install the four swing arm pivot point covers (57, 58 left & 59, 60 right) with six 3.5mm x 12mm screws (113).
- Install the four covers (53x2 & 54x2) to the ends of the pedal arms with four M5 x 12mm screws (78). **These covers can be installed upside down!! There is an arrow on the inside of each cover to indicate correct installation direction.**
- Install the four covers (55 & 56, 2 pcs each) at the connection point at the bottom of the swing arms using four 3.5mm x 12mm screws (113) and four M5 x 12mm screws (78). Install the front stabilizer cover (47) with two M5 x 12mm screws (78).

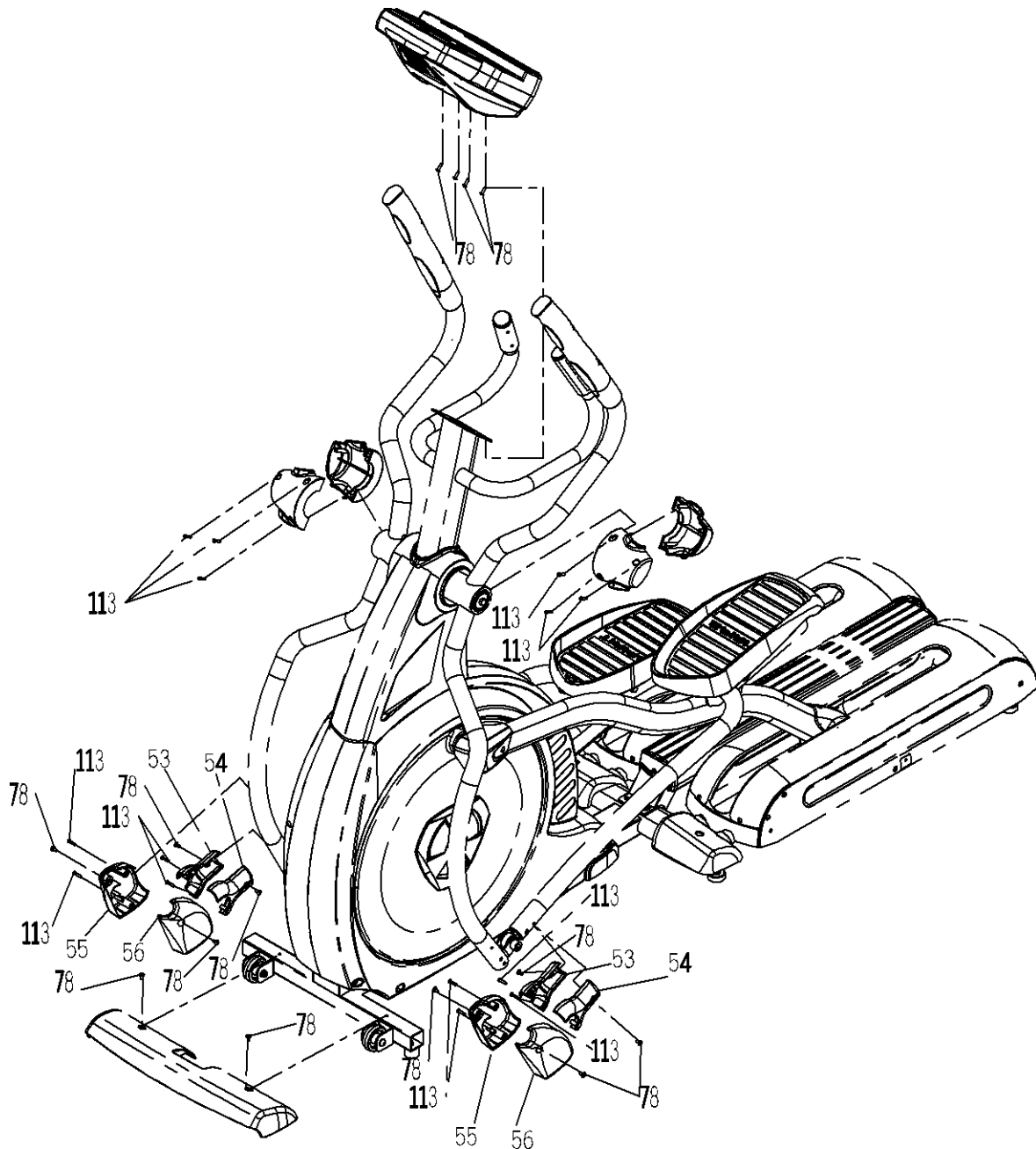

GETTING ON / OFF YOUR ELLIPTICAL

IMPORTANT

The elliptical comes with two Dual Action Handles and a Stationary Handlebar. Always hold the Stationary Handlebar when getting on and off the elliptical. First time users should familiarize themselves with using the elliptical by using the Stationary Handlebar first and then progressing to the Dual Action Handles.

Once you have familiarized yourself with using the elliptical, you can progress to using the Dual Action Handles to provide a total body workout. Hands can be positioned on the Dual Action Handles at the most appropriate position for your height and arm length.

Caution should always be taken when getting on and off any exercise machine. Please follow the safety steps below.

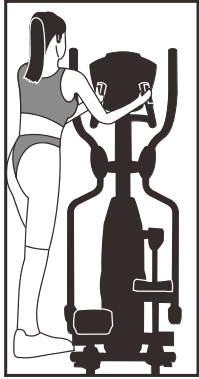

Ensure the left Foot Pedal is in the lowest position and grasp the Stationary Handlebar with both hands.

Place your left foot on the left Foot Pedal and get secure.

Lift your right foot over machine and place on right Foot Pedal. Get balanced and begin your workout.

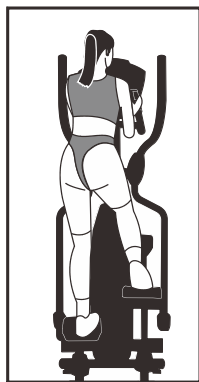
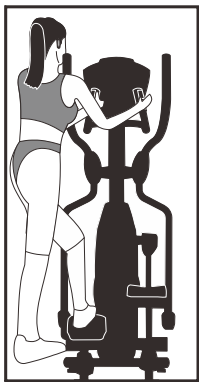

Important

To get off, come to a complete stop and reverse the procedure.

Always wear rubber-soled shoes, such as tennis shoes.

It is recommended that you keep at least one hand on the Stationary Handlebar at all times, especially when getting on or off. If you are performing a walking action with your arms, or doing upper body strength training exercises, ensure you are well balanced.

All equipment should be set-up and operated on solid, level surfaces.

Correct Position



Your body should be in an upright position so that your back is straight. Keep your head up to minimize neck and upper back strain. Always try and use the elliptical in a rhythmical and smooth motion. If you find yourself feeling uncomfortable, or experience a surging type feeling, there is probably too much tension.

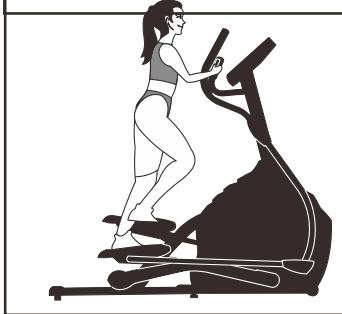

The elliptical can be used in forward or reverse motion.



When going in reverse, bend your knees slightly more. More emphasis is on the buttocks and hamstrings in the reverse motion.

MOVING YOUR ELLIPTICAL

The elliptical can be easily moved.

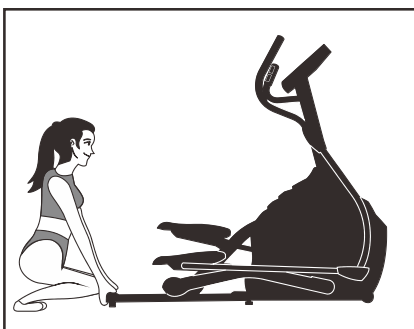

1. At the rear of the machine squat down and grasp the rear stabilizer bar.

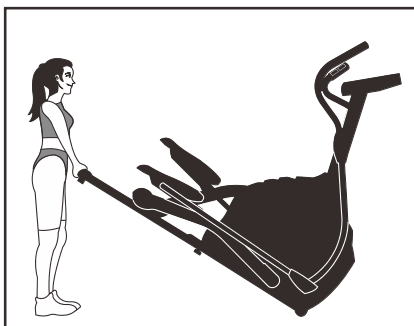

2. Lift the rear of the machine using your legs until the wheels in the front engage with the ground.

Console Operation

■ Console

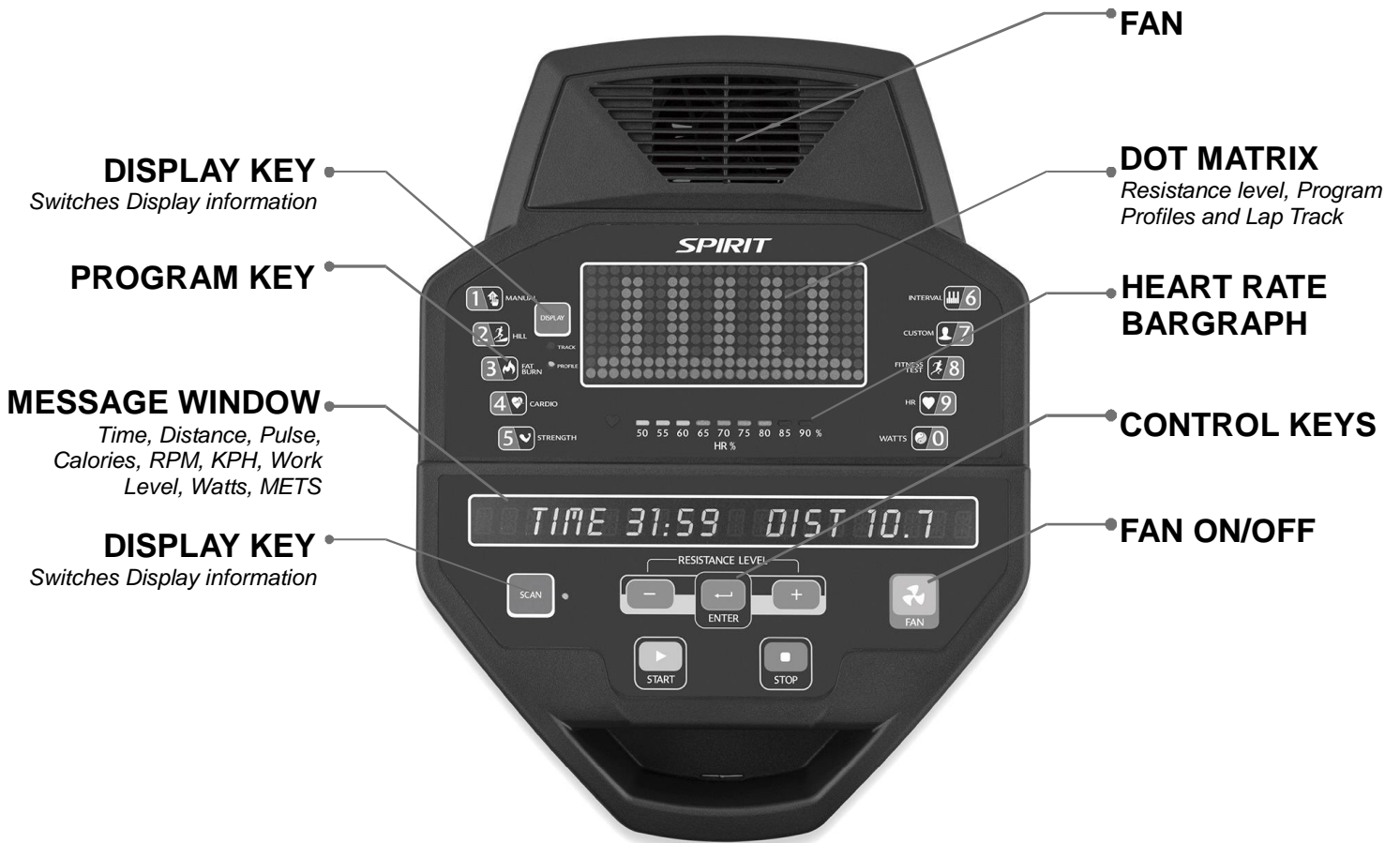

Power on

The elliptical has a built-in generator for power and does not need to be plugged into an AC outlet. To power up the elliptical simply start to pedal, the console will turn on automatically.

When initially powered on the console will perform an internal self-test. During this time all the lights will turn on for a short time. When the lights go off the dot matrix display will show a software version (i.e. VER 1.0) and the message window will display an odometer reading. The odometer reading displays how many hours the Elliptical has been used and how many virtual miles the Elliptical has gone. The display shows: ODO 123 MI 123 HRS.

The odometer will remain displayed for only a few seconds then the console will go to the start up display. The dot matrix display will be scrolling through the different profiles, showing the programs, and the message window will be scrolling the start up message. You may now begin your workout program.

Console Operation

Quick Start

This is the quickest way to start a workout. After the console powers up you just press the Start key to begin. This will initiate the Quick Start mode. In Quick Start the Time will count up from zero, all workout data will start to accrue and the workload may be adjusted manually by pressing the Up and Down buttons. The dot matrix display will show a ¼ mile (0.4KM) track display or just the bottom row lit at first, depending on how the display button has been set (see Basic information below). As you increase the workload more rows will light indicating a harder workout. The elliptical will get harder to pedal as the rows increase. The dot matrix has 24 columns of lights and each column represents 1 minute. At the end of the 24th column (or 24 minutes of work) the display will wrap around and start at the first column again.

There are 40 levels of resistance – displayed as 10 rows of lights - available for plenty of variety. The first 10 levels are very easy workloads, and the changes between levels are set to a good progression for de-conditioned users. Levels 10-20 are more challenging but the increases from one level to the next remain small. Levels 20-30 start getting tough as the levels jump more dramatically. Levels 30-40 are extremely hard and are good for short interval peaks and elite athletic training.

Basic information

The **Dot Matrix, or Profile Window**, has two display modes. When you begin a program the dot matrix will display the workout Profile. To the left of the dot matrix there is a button labeled Display. Pressing this button once will switch the display to show a quarter mile track. If the Display button is pressed again the dot matrix will switch back and forth between Track and Profile mode every few seconds. To turn off the scan mode press the Display key again. This will return you to the profile display mode.

The **Message Window** will initially be displaying Time and Distance information. On the bottom left of the message window is a button labeled Display. Each time this Display button is pressed the next set of information will appear, four windows in all. In order: Time and Distance, Pulse and Kcal (Calories), Speed in RPM and MPH, Work Level and Watts, then METs. If the Display button is pressed during the METs display the Scan light will come on and the message window will show each set of data for four seconds then switch to the next set of data in a continuous loop. Pressing the Display button again will bring you back to the beginning.

Below the Dot matrix display is a **Heart Icon** and a **Bar Graph**. The Elliptical has a built in heart rate monitoring system. Simply grasping the hand pulse sensors, or wearing a heart rate chest belt transmitter, will start the **Heart Icon** blinking (this may take a few seconds). The Message Window will display your heart rate, or Pulse, in beats per minute. The **Bar Graph** represents the percentage of your maximum heart rate you are currently achieving. NOTE: You must enter your age during program setup for the Bar Graph to be accurate. Refer to Heart Rate section for details about these features and how they can help you work out more efficiently.

The **Stop/Reset** button actually has several functions. Pressing the Stop/Reset key once during a program will **Pause** the program for 5 minutes (when you stop pedaling the display will turn off but the memory will be saved for 5 minutes just like the pause mode). If the Stop/Reset button is pressed twice during a workout the program will end and the console will return to the start up screen. If the Stop/Reset key is held down for 3 seconds the console will perform a complete **Reset**. During data entry for a program the Stop/Reset key performs a **Previous Screen** function. This allows you to go back one step in the programming each time you press the Stop/Reset key.

The **Program Keys** are used to preview each program. When you first turn the console on you may press each program key to preview what the program profile looks like. If you decide that you want to try a program, press the corresponding program key and then press the Enter key to select the program and enter into the data-setup mode.

The program keys also act as a **Number Key Pad** when you are in the data-setup mode. Under each program key is a number. If you are setting new data such as Age, weight etc., you can use these keys to enter the numbers quickly.

The console includes a built-in fan to help keep you cool. To turn the fan on press the key on the right side, front of the console

Programming the console

Each of the programs can be customized with your personal information and changed to suit your needs. Some of the information asked for is necessary to ensure the readouts are correct. You will be asked for your **Age** and **Weight**. Entering your **Age** ensures that the Heart Rate bar graph shows the correct number. Your Age is also necessary during the Heart Rate control program to ensure the correct settings are in the program for your Age. Otherwise the work settings could be too high or low for you; entering your **Weight** aides in calculating a more correct **Calorie** reading. Although we cannot provide an exact calorie count we do want to be as close as possible.

Entering/Changing Settings

When you enter a program (by pressing a program key, then enter key) you have the option of entering your own personal settings. If you want to workout without entering new settings then just press the Start key. This will bypass the programming of data and take you directly to the start of your workout. If you want to change the personal settings then just follow the instructions in the message window. If you start a program without changing the settings the default - or pre-saved – settings will be used.

Manual

The Manual program works as the name implies, manually. This means that you control the workload yourself and not the computer. To start the Manual program follow the instructions below or just press the Manual button then the Enter button and follow the directions in the message window.

1. Press the **Manual** key then press the **Enter** key.
2. The message window will ask you to enter your **Age**. You may enter your Age, using the Up and Down keys or the numeric key pad, then press the Enter key to accept the new number and proceed on to the next screen.
3. You are now asked to enter your **Weight**. You may adjust the Weight number using the Up and Down keys, or the numeric key pad, then press enter to continue.
4. The next setting is **Time**. You may adjust the Time and press enter to continue.
5. Now you are finished editing the settings and can begin your workout by pressing the Start key. You can also go back and modify your settings by pressing the Enter key. NOTE: At any time during the editing of Data you can press the Stop key to go back one level, or screen.
6. The program automatically starts you at level one. This is the easiest level and it is a good idea to stay at level one for a while to warm up. If you want to increase the work load at any time press the Up key; the Down key will decrease the workload.
7. During the Manual program you will be able to scroll through the data in the message window by pressing the adjacent **Display key**. You may also switch between the profile display and a quarter mile track by pressing the Display key adjacent to the dot matrix display.
8. When the program ends you may press Start to begin the same program again or Stop to exit the program, or you can save the program you just completed as a **custom program** by pressing the Custom key and following the instructions in the message window.

Preset Programs

The elliptical has five different programs that have been designed for a variety of workout goals. These five programs have factory preset profiles for achieving these different goals. The initial built-in level of difficulty for each program is set to a relatively easy level. You may adjust the level of difficulty (Max level) for each program before beginning by following the instructions in the message window after selecting your program.

HILL

The **Hill** program simulates going up and down a hill. The resistance in the pedals will steadily increase and then decrease during the program.

Work Profile



FATBURN

The **Fat Burn** program is designed, as the name implies, to maximize the burning of fat. There are many schools of thought on the best way to burn fat but most experts agree that a lower exertion level that stays at a steady workload is the best. The absolute best way to burn fat is to keep your heart rate at around 60% to 70% of its maximum potential. This program does not use heart rate but simulates a lower, steady exertion workout.

Work Profile

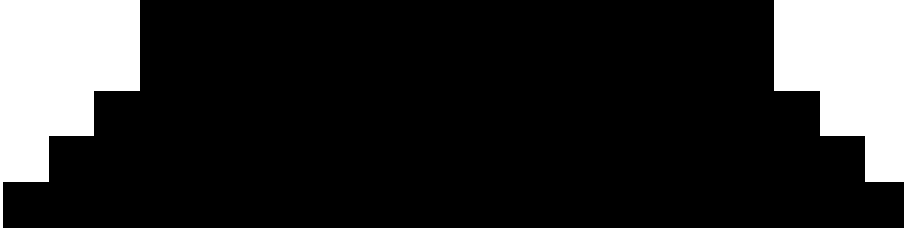

Cardio

The **Cardio** program is designed to increase your Cardio vascular function. This is exercise for your heart and lungs. It will build up your heart muscle and increase blood flow and lung capacity. This is achieved by incorporating a higher level of exertion with slight fluctuations in work.

Work Profile



Strength

The **Strength** program is designed to increase muscular strength in your lower body. This program will steadily increase in resistance to a high level and then keeps you there. This is designed to strengthen and tone your legs and glutes.

Work Profile



Interval

The **Interval** program takes you through high levels of intensity followed by periods of low intensity. This program increases your endurance by depleting your oxygen level followed by periods of recovery to replenish oxygen. Your cardio vascular system gets programmed to use oxygen more efficiently this way.

Work Profile

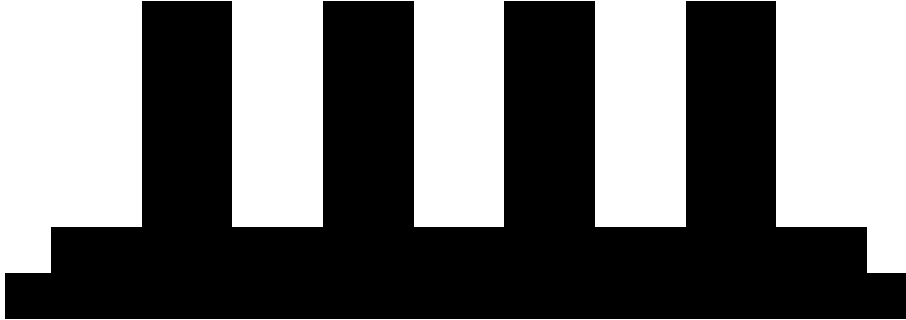

Programming Preset Programs:

1. Select the desired program button then press the **Enter** key.
2. The message window will ask you to enter your **Age**. You may adjust the age setting, using the Up and Down keys, then press the Enter key to accept the new number and proceed on to the next screen.
3. You are now asked to enter your **Weight**. You may adjust the weight number using the Up and Down keys, then press enter to continue.
4. Next is **Time**. You may adjust the Time and press enter to continue.
5. Now you are asked to adjust the **Max Level**. This is the peak exertion level you will experience during the program (at the top of the hill). Adjust the level and then press enter.
6. Now you are finished editing the settings and can begin your workout by pressing the Start key. You can also go back and modify your settings by pressing the Stop key to go back one level, or screen.
7. If you want to increase or decrease the workload at any time during the program press the Up or Down key. This will change the workload settings of the entire profile, although the profile picture on the screen will not change. The reason for this is so that you can see the entire profile at all times. If the profile picture is changed it will look distorted and not a true representation of the actual profile. When you make a change to the workload, the message window will show the current column, and program maximum, levels of work.
8. During the program you will be able to scroll through the data in the message window by pressing the **Display** key next to the message window.
9. When the program ends the message window will show a summary of your workout. The summary will be displayed for a short time then the console will return to the start-up display.

Custom User Defined Program

The custom program allows you to build and save a custom program. You can build your own custom program by following the instructions below or you can save any other preset program you complete as a custom program. The custom program allows you to further personalize it by adding your facility name.

1. Press the **Custom** key. The message window will show a welcome message; if you had previously saved a program the message will contain the name you gave it. Then press the **Enter** key to begin programming.
2. When you press enter, the message window will show "Name – A", if there is no name saved. If the name "Custom Workout" had been previously saved the message window will show "Name – Custom Workout" and the C in Custom will be blinking. If there is a name saved you can change it or you may press the Stop key to keep the name and continue to the next step. If you want to enter a name use the Up and/or the Down key to change the first letter then press Enter to save the first letter and continue to the next letter. When you have finished entering the name press the Stop key to save the name and continue to the next step.
3. The message window will ask you to enter your **Age**. You may enter your Age, using the Up and Down keys or the numeric key pad, then press the Enter key to accept the new number and proceed on to the next screen.
4. You are now asked to enter your **Weight**. You may adjust the Weight number using the Up and Down keys or the numeric key pad then press enter to continue.
5. Next is **Time**. You may adjust the Time and press enter to continue.
6. Now you are asked to adjust the **Max Level**. This is the peak exertion level you will experience during the program. Adjust the level and then press enter.
7. Now the first column will be blinking and you are asked to adjust the level for the first segment of the workout. When you finish adjusting the first segment, or if you don't want to change, then press enter to continue to the next segment.
8. The next segment will show the same level as the previously adjusted segment. Repeat the same process as the last segment then press enter. Continue this process until all twenty segments have been set.
9. The message window will then tell you to press enter to save the program. After saving the program the message window says "New program saved" then will give you the option to Start or modify the program. Pressing Stop will exit to the start up screen.
10. If you want to increase or decrease the workload at any time during the program press the Up or Down key. This will only affect the workload for the present position in the profile. When the profile changes to the next column it will return to the preset work level.
11. During the User 1 or User 2 program you will be able to scroll through the data in the message window by pressing the adjacent **Display key**. Switch between the profile display and a quarter mile track by pressing the Display key adjacent to the matrix.

Fit-Test

The fitness test will assess your fitness level and give a score at the end of the test. This score is not a Vo2 max number, but just a number to use as a reference. You can take the test every month and the score will be higher as your level of fitness improves. The test will take anywhere from 6–15 minutes. The test will ask you to maintain a pedal speed of 50 RPM and will automatically make adjustments to the work load depending on your heart rate response to set work levels. The test ends when you reach your target heart rate which is 85% of your maximum heart rate (Max HR = 220 – your age) or if your HR exceeds 110 BPM for 2 stages.

Workload chart for male or very fit female:

1st Stage				Level 12 - 50 watts - 300 kgm/min					
HR		< 90			90 - 105			> 105	
2nd Stage		Level 29 - 150 watts - 900 kgm/min			Level 26 - 125 watts - 750 kgm/min			Level 23 - 100 watts - 600 kgm/min	
HR	HR <120	HR 120-135	HR >135	HR <120	HR 120-135	HR >135	HR <120	HR 120-135	HR >135
3rd stage	Level 36 - 225 watts - 1350 kgm/min	Level 34 - 200 watts - 1200 kgm/min	Level 32 - 175 watts - 1050 kgm/min	Level 34 - 200 watts - 1200 kgm/min	Level 32 - 175 watts - 1050 kgm/min	Level 29 - 150 watts - 900 kgm/min	Level 32 - 175 watts - 1050 kgm/min	Level 29 - 150 watts - 900 kgm/min	Level 26 - 125 watts - 750 kgm/min

Workload chart for female or de-conditioned male

		1st Stage	Level 5 (25W) 150 kgm/min	
Heart Rate	HR<80	HR: 80-90	HR: 90-100	HR>100
2nd Stage	Level 26 (125W) 750 kgm/min	Level 23 (100W) 600 kgm/min	Level 18 (75W) 450 kgm/min	Level 12 (50W) 300 kgm/min
3rd Stage	Level 29 (150W) 900 kgm/min	Level 26 (125W) 750 kgm/min	Level 23 (100W) 600 kgm/min	Level 18 (75W) 450 kgm/min
4th Stage (if needed)	Level 32 (175W) 1050 kgm/min	Level 29 (150W) 900 kgm/min	Level 25 (117W) 700 kgm/min	Level 23 (100W) 600 kgm/min

Fitness test programming:

1. Press the Fit-test button and press enter.
2. The message window will ask you to enter your **Age**. You may adjust the age setting, using the Up and Down keys then press the Enter key to accept the new number and proceed on to the next screen.
3. You are now asked to enter your **Weight**. You may adjust the weight number using the Up and Down keys then press enter to continue.
4. Now press Start to begin the test.

Before the test:

- Make sure you are in good health; check with your physician before performing any exercise if you are over the age of 35 or persons with pre-existing health conditions.
- Make sure you have warmed up and stretched before taking the test.
- Do not take in caffeine before the test.
- Hold the hand grips gently, do not tense up.

During the test:

- The console must be receiving a steady heart rate for the test to begin. You may use the hand pulse sensors or wear a heart rate chest strap transmitter.
- You must maintain a steady 50 RPM pedal speed. If your pedal speed drops below 48 RPM or goes above 52 RPM the console will emit a steady beeping sound until you are within this range.
- You may scroll through the various data readings in the message window by pressing the Display button under the message window.
 1. The message window will always display your pedal speed on the right side to help you maintain 50RPM.
 2. The data shown during the test is:
 - a. **Work in KGM** is actually an abbreviated form of kg-m/min. which is a work measurement of kilogram-force meter/minute
 - b. **Work in Watts** (1 watt is equal to 6.11829727787 kg-m/min.)
 - c. **HR** is your actual heart rate; **TGT** is the target heart rate to reach to end the test.
 - d. **Time** is the total elapsed time of the test.

After the test:

- Cool down for about one to three minutes.
- Take note of your score because the console will automatically return to the start-up mode after a few minutes.

What your score means:

VO2max Chart for males and very fit females

	18-25 years old	26-35 years old	36-45 years old	46-55 years old	56-65 years old	65+ years old
excellent	>60	>56	>51	>45	>41	>37
good	52-60	49-56	43-51	39-45	36-41	33-37
above average	47-51	43-48	39-42	35-38	32-35	29-32
average	42-46	40-42	35-38	32-35	30-31	26-28
below average	37-41	35-39	31-34	29-31	26-29	22-25
poor	30-36	30-34	26-30	25-28	22-25	20-21
very poor	<30	<30	<26	<25	<22	<20

VO2max Chart for females and de-conditioned males

	18-25 years old	26-35 years old	36-45 years old	46-55 years old	56-65 years old	65+ years old
excellent	56	52	45	40	37	32
good	47-56	45-52	38-45	34-40	32-37	28-32
above average	42-46	39-44	34-37	31-33	28-31	25-27
average	38-41	35-38	31-33	28-30	25-27	22-24
below average	33-37	31-34	27-30	25-27	22-24	19-22
poor	28-32	26-30	22-26	20-24	18-21	17-18
very poor	<28	<26	<22	<20	<18	<17

• Heart Rate Training

A word about Heart Rate:

The old motto, “no pain, no gain”, is a myth that has been overpowered by the benefits of exercising comfortably. A great deal of this success has been promoted by the use of heart rate monitors. With the proper use of a heart rate monitor, many people find that their usual choice of exercise intensity was either too high or too low and exercise is much more enjoyable by maintaining their heart rate in the desired benefit range.

To determine the benefit range in which you wish to train, you must first determine your Maximum Heart Rate. This can be accomplished by using the following formula: 220 minus your age. This will give you the Maximum heart rate (MHR) for someone of your age. To determine the effective heart rate range for specific goals you simply calculate a percentage your MHR. Your Heart rate training zone is 50% to 90% of your maximum heart rate. 60% of your MHR is the zone that burns fat while 80% is for strengthening the cardiovascular system. This 60% to 80% is the zone to stay in for maximum benefit.

For someone who is 40 years old their target heart rate zone is calculated:

$220 - 40 = 180$ (maximum heart rate)
 $180 \times .6 = 108$ beats per minute (60% of maximum)
 $180 \times .8 = 144$ beats per minute (80% of maximum)

So for a 40 year old the training zone would be 108 to 144 beats per minute.

If you enter your age during programming the console will perform this calculation automatically. Entering your age is used for the Heart Rate control programs. After calculating your Maximum Heart Rate you can decide upon which goal you would like to pursue.

The two most popular reasons for, or goals, of exercise are cardiovascular fitness (training for the heart and lungs) and weight control. The black columns on the chart above represent the Maximum Heart Rate for a person whose age is listed at the bottom of each column. The training heart rate, for either cardiovascular fitness or weight loss, is represented by two different lines that cut diagonally through the chart. A definition of the lines' goal is in the bottom left-hand corner of the chart. If your goal is cardiovascular fitness or if it is weight loss, it can be achieved by training at 80% or 60%, respectively, of your Maximum Heart Rate on a schedule approved by your physician. Consult your physician before participating in any exercise program.

With all Heart Rate Control elliptical machines you may use the heart rate monitor feature without using the Heart Rate Control program. This function can be used during manual mode or during any of the nine different programs. The Heart Rate Control program automatically controls resistance at the pedals.

”WARNING” Heart rate monitoring system may be inaccurate. Over exercise may result in injury or death. If you feel faint stop exercising immediately.

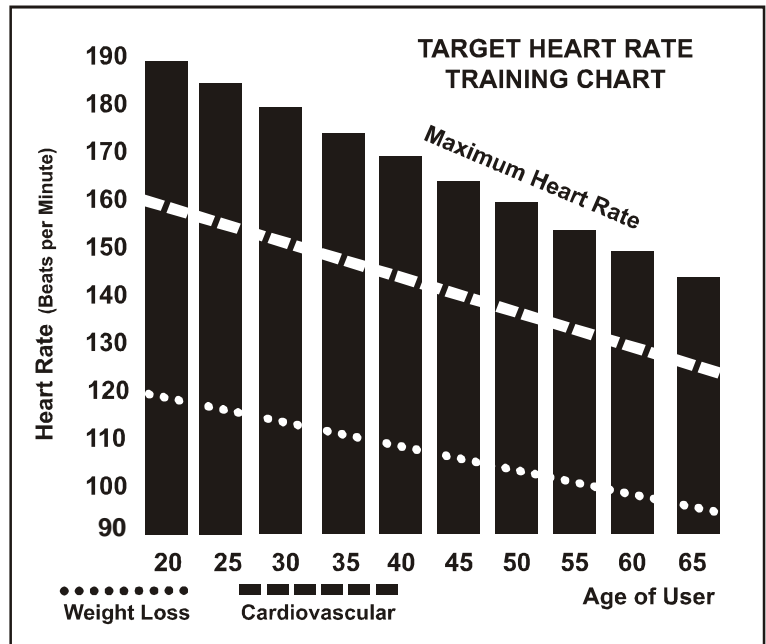

Rate of Perceived Exertion

Heart rate is important but listening to your body also has a lot of advantages. There are more variables involved in how hard you should workout than just heart rate. Your stress level, physical health, emotional health, temperature, humidity, the time of day, the last time you ate and what you ate, all contribute to the intensity at which you should workout. If you listen to your body, it will tell you all of these things.

The rate of perceived exertion (RPE), also know as the Borg scale, was developed by Swedish physiologist G.A.V. Borg. This scale rates exercise intensity from 6 to 20 depending upon how you feel or the perception of your effort.

The scale is as follows:

Rating Perception of Effort

- 6 Minimal
- 7 Very, very light
- 8 Very, very light +
- 9 Very light
- 10 Very light +
- 11 Fairly light
- 12 Comfortable
- 13 Somewhat hard
- 14 Somewhat hard +
- 15 Hard
- 16 Hard +
- 17 Very hard
- 18 Very hard +
- 19 Very, very hard
- 20 Maximal

You can get an approximate heart rate level for each rating by simply adding a zero to each rating. For example a rating of 12 will result in an approximate heart rate of 120 beats per minute. Your RPE will vary depending up the factors discussed earlier. That is the major benefit of this type of training. If your body is strong and rested, you will feel strong and your pace will feel easier. When your body is in this condition, you are able to train harder and the RPE will support this. If you are feeling tired and sluggish, it is because your body needs a break. In this condition, your pace will feel harder. Again, this will show up in your RPE and you will train at the proper level for that day.

Using a Heart Rate Transmitter

How to wear your wireless chest strap transmitter:

1. Attach the transmitter to the elastic strap using the locking parts.
2. Adjust the strap as tightly as possible as long as the strap is not too tight to remain comfortable.
3. Position the transmitter with the logo centered in the middle of your body facing away from your chest (some people must position the transmitter slightly left of center). Attach the final end of the elastic strap by inserting the round end and, using the locking parts, secure the transmitter and strap around your chest.

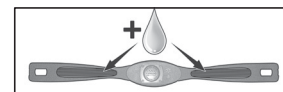
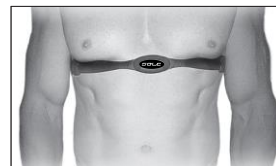

4. Position the transmitter immediately below the pectoral muscles.
5. Sweat is the best conductor to measure very minute heart beat electrical signals. However, plain water can also be used to pre-wet the electrodes (2 ribbed oval areas on the reverse side of the belt and both sides of the transmitter). It's also recommended that you wear the transmitter strap a few minutes before your work out. Some users, because of body chemistry, have a more difficult time in achieving a strong, steady signal at the beginning. After "warming up", this problem lessens. As noted, wearing clothing over the transmitter/strap doesn't affect performance.
6. Your workout must be within range - distance between transmitter/receiver – to achieve a strong steady signal. The length of range may vary somewhat but generally stay close enough to the console to maintain good, strong, reliable readings. Wearing the transmitter immediately against bare skin assures you of proper operation. If you wish, you may wear the transmitter over a shirt. To do so, moisten the areas of the shirt that the electrodes will rest upon.

Note: The transmitter is automatically activated when it detects activity from the user's heart. Additionally, it automatically deactivates when it does not receive any activity. Although the transmitter is water resistant, moisture can have the effect of creating false signals, so you should take precautions to completely dry the transmitter after use to prolong battery life (estimated transmitter battery life is 2500 hours). The replacement battery is Panasonic CR2032.

ERRATIC OPERATION

CAUTION! Do not use this exercise equipment for Heart Rate unless a steady, solid Actual Heart Rate value is being displayed. High, wild, random numbers being displayed indicate a problem.

Areas to look for interference which may cause erratic heart rate:

1. Microwave ovens, TV's, small exercise equipments, etc.
2. Fluorescent lights.
3. Some household security systems.
4. Perimeter fence for a pet.
5. Some people have problems with the transmitter picking up a signal from their skin. If you have problems try wearing the transmitter upside down. Normally the transmitter will be oriented so the logo is right side up.
6. The antenna that picks up your heart rate is very sensitive. If there is an outside noise source, turning the whole machine 90 degrees may de-tune the interference.
7. Another Individual wearing a transmitter within 3' of your machine's console.

If you continue to experience problems contact your dealer.

Heart Rate Control (HRC) Program operation

To start the **HRC** program follow the instructions below or just press the HRC key then the Enter button and follow the directions in the message window.

1. Press the **HRC** key then press the **Enter** key.
2. The message window will ask you to enter your **Age**. You may enter your Age, using the Up and Down keys or the numeric key pad, then press the Enter key to accept the new number and proceed on to the next screen.
3. You are now asked to enter your **Weight**. You may adjust the Weight number using the Up and Down keys or the numeric key pad, then press enter to continue.
4. Next is **Time**. You may adjust the Time and press enter to continue.
5. Now you are asked to adjust the **Heart rate Level**. This is the heart rate level you will experience during the program. Adjust the level and then press enter.
6. Now you are finished editing the settings and can begin your workout by pressing the Start key. You can also go back and modify your settings by pressing the Enter key. NOTE: At any time during the editing of Data you can press the Stop key to go back one level, or screen.
7. If you want to increase or decrease the workload at any time during the program press the Up or Down key. This will allow you to change your target heart rate at any time during the program.
8. During the HRC program you will be able to scroll through the data in the message window by pressing the adjacent **Display key**.
9. When the program ends you may press Start to begin the same program again or Stop to exit the program or you can save the program you just completed as a **custom user program** by pressing a User key and following the instructions in the message window.

Watts Program operation (Not to be used for medical purposes)

The Watts program provides a constant power mode that automatically adjusts the resistance level at the pedals whenever you change speeds to keep you working at a constant power level. Another way to think of this program is that it keeps you working at a continuous rate of calorie burn. To start the **Watts** program follow the instructions below or just press the **Watts** key then the Enter button and follow the directions in the message window.

1. Press the **Watts** key then press the **Enter** key.
2. The message window will ask you to enter your **Age**. You may enter your Age, using the Up and Down keys or the numeric key pad, then press the Enter key to accept the new number and proceed on to the next screen.
3. You are now asked to enter your **Weight**. You may adjust the Weight number using the Up and Down keys or the numeric key pad then press enter to continue.
4. Next is **Time**. You may adjust the Time and press enter to continue.
5. Now you are asked to adjust the **Target Watts**. This is the constant power you will experience during the program. Adjust the up/down and then press enter.
6. Now you are finished editing the settings and can begin your workout by pressing the Start key. You can also go back and modify your settings by pressing the Enter key. NOTE: At any time during the editing of Data you can press the Stop key to go back one level, or screen.
7. If you want to increase or decrease the workload at any time during the program press the Up or Down key. This will allow you to change your target Watts at any time during the program.
8. During the **Watts** program you will be able to scroll through the data in the message window by pressing the adjacent **Display key**.

Maintenance:

1. Wipe down all areas in the sweat path with a damp cloth after each workout.
2. If a squeak, thump, clicking or rough feeling develops the main cause is most likely one of two reasons:
 - i. The hardware was not sufficiently tightened during assembly. All bolts that were installed during assembly need to be tightened as much as possible. It may be necessary to use a larger wrench than the one provided if you cannot tighten the bolts sufficiently. I cannot stress this point enough; 90% of calls to the service department for noise issues can be traced to loose hardware or the rear rails being dirty.
 - ii. Dirt build-up on the rear rails and polyurethane wheels are also a source of noise. Noise from build-up on the rails can cause a thumping sound that you would swear is coming from inside the main body of the machine because noise travels, and is amplified, in the tubing of the frame. Clean the rails and wheels with a lint free cloth and rubbing alcohol. Stubborn build-up can be removed with your thumbnail or a non-metallic scraper, like the back edge of a plastic knife.
 - iii. Lubrication of rails: Only lubricate the rails if there is a persistent squeaking from the wheels. If there is no squeaking then it is preferable to not use lubrication as it will attract dirt and dust onto the wheels and rails. After cleaning, apply a small amount of lubricant on the rails with your fingers or a lint free cloth. You only need a thin coat of lubrication, wipe off any excess.
3. If squeaks or other noises persist, check that the unit is properly leveled. There are 4 leveling pads on the bottom of the rear rails, use a 14mm wrench (or adjustable wrench) to adjust the levelers.

Maintenance Menu in console software:

The console has built in maintenance/diagnostic software. The software will allow you to change the console settings from English to Metric and turn off the beeping of the speaker when a key is pressed for example. To enter the Maintenance menu (may be called Engineering mode, depending on version) press and hold down the Start, Stop and Enter keys. Keep holding the keys down for about 5 seconds and the message window will display "ALTXXX Engineering mode". Press the enter button to access the menu below:

- a. **Key test** (will allow you to test all the keys to make sure they are functioning)
- b. **Display test** (tests all the display functions)
- c. **Functions** (Press enter to access settings)
 - i. **Sleep mode** (Turn on to have the console power down automatically after 20 minutes of inactivity)
 - ii. **Pause Mode** (Turn on allow 5 minutes of pause, turn off to have the console pause indefinitely)
 - iii. **ODO reset** (reset the odometer)
 - iv. **Units** (Set to English or Metric display readings)
 - v. **Beep** (Turn on or off the beep when a key is pressed)
 - vi. **D/A test** (tests the brake resistance)
 - vii. **Elliptical or Bike** (sets the console software calculations)
- d. **Security** (Allows you to lock the keypad so no unauthorized use is allowed)

EXPLODED VIEW DIAGRAM

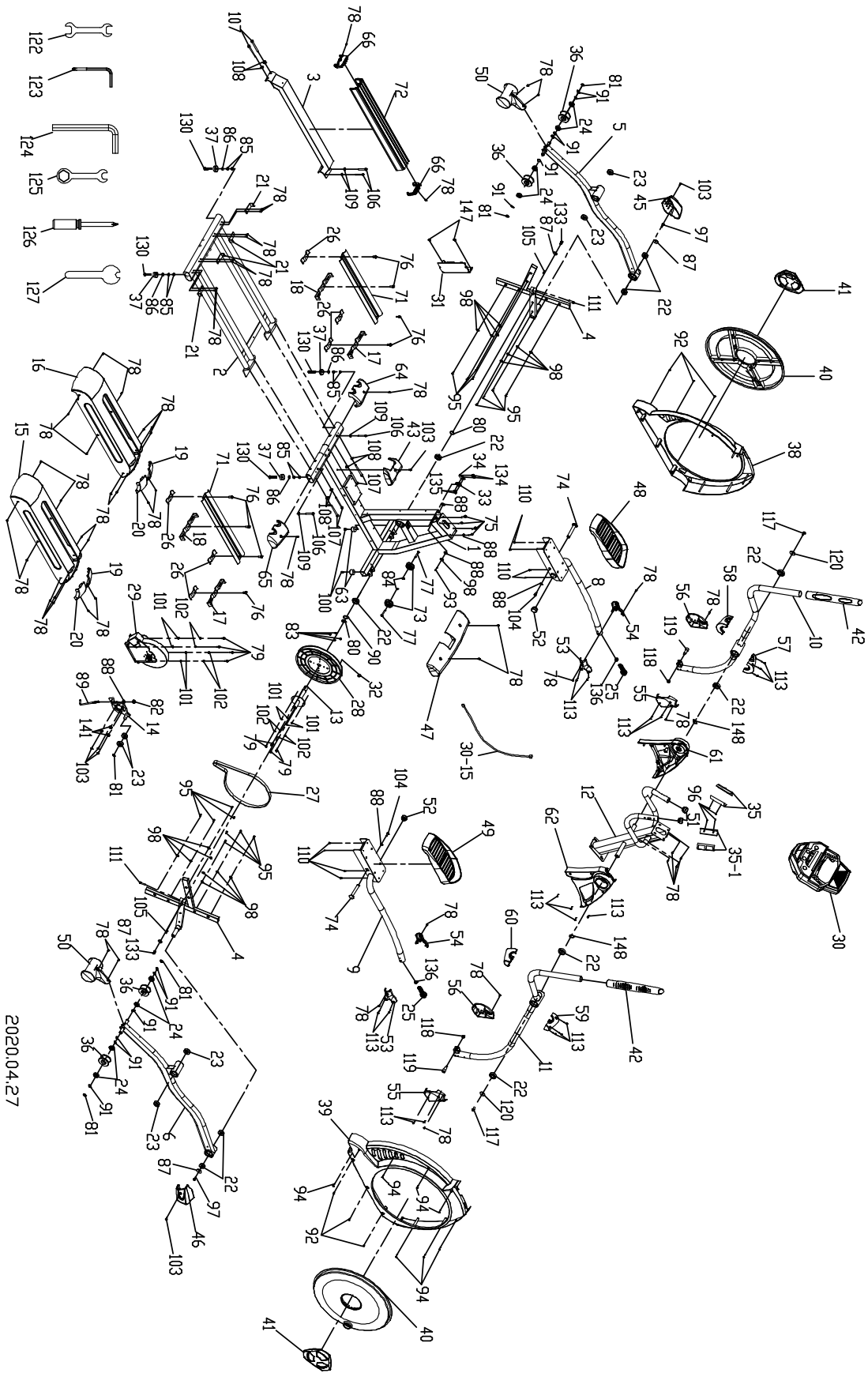

2020.04.27

PARTS LIST

Dwg #	Part description	Q'ty
1	Main Frame	1
2	Rail Assembly	1
3	Rail Support Assembly	1
4	Cross Bar	2
5	Pedal Arm(L)	1
6	Pedal Arm(R)	1
8	Connecting Arm (L)	1
9	Connecting Arm (R)	1
10	Swing Arm (L)	1
11	Swing Arm (R)	1
12	Console Mast	1
13	Crank Axle	1
14	Idler Wheel Assembly	1
15	Right Shroud	1
16	Left Shroud	1
17	Rear Mounting Bracket (A)	2
18	Rear Mounting Bracket (B)	2
19	Front Cover, Top (L)	2
20	Front Cover, Top (R)	2
21	Rear L-Plate	4
22	6005_Bearing(NTN)	10
23	6203_Bearing	6
24	6003_Bearing	8
25	Rod End Bearing	2
26	Retaining Bracket, Aluminum Track	6
27	Drive Belt	1
28	Drive Pulley, 330mm	1
29	Flywheel	1
30	Console Assembly	1
30~15	1400m/m_Computer Cable	1
31	Generator/Brake Controller	1
32	Magnet	1
33	Sensor W/Cable	1
34	Sensor Rack	1
35	850m/m_Handpulse W/Cable Assembly	1
35~1	850m/m_Handpulse W/Cable Assembly(Red)	1
36	Sliding Wheel , Urethane	4
37	Rubber Foot	4
38	Side case (L)	1
39	Side case (R)	1
40	Round Disk	2
41	Round Disk Cover	2
42	Handle Bar Axle Inner Cover	2
43	Incline Bottom Cover	1
45	Pedal Arm Cover (L)	1
46	Pedal Arm Cover (R)	1

Dwg #	Part description	Q'ty
47	Front Stabilizer Cover	1
48	Pedal (L)	1
49	Pedal (R)	1
50	Slide Wheel Cover	2
51	Button Head Plug	2
52	Pedal End Cover	2
53	Connecting Arm Cover A (R)	2
54	Connecting Arm Cover A (L)	2
55	Connecting Arm Cover B (R)	2
56	Connecting Arm Cover B (L)	2
57	Front Handle Bar Cover (L)	1
58	Rear Handle Bar Cover (L)	1
59	Front Handle Bar Cover (R)	1
60	Rear Handle Bar Cover (R)	1
61	Console Mast Cover(L)	1
62	Console Mast Cover(R)	1
63	Rubber Foot Pad	2
64	Rear Stabilizer Cover (A)	1
65	Rear Stabilizer Cover (B)	1
66	End Cap, Aluminum Step Rail	2
69	Drink Bottle Assembly	1
70	Drink Bottle Holder	1
71	Aluminum Track	2
72	Aluminum Step Rail	1
73	Transportation Wheel	2
74	Ø17 x 117m/m_Carriage Bolt	2
75	M8 x 1.25 x 25m/m_Hex Socket Cap Screw	4
76	5/16" x 3/4" _Hex Head Bolt	8
77	5/16" _Button Head Socket Bolt	2
78	M5 x 12m/m_Phillips Head Screw	52
79	1/4" x 3/4" _Hex Head Bolt	8
80	Ø25_C Ring	2
81	Ø17_C Ring	5
82	M8 x 9T_Nyloc Nut	1
83	1/4" _Nyloc Nut	4
84	5/16" x 7t_Nyloc Nut	2
85	3/8" x 7T_Nut	8
86	3/8" x 19 x 1.5T_Flat Washer	4
87	5/16" x 35 x 1.5T_Flat Washer	4
88	5/16" x 23 x 1.5T_Flat Washer	6
89	M8 x 170m/m_J Bolt	1
90	Ø25_Wave Washer	1
91	Ø17_Wave Washer	12
92	5 x 16m/m_Tapping Screw	6
93	4 x 15m/m_Sheet Metal Screw	1
94	4 x 19m/m_Sheet Metal Screw	7
95	5 x 16m/m_Tapping Screw	16
96	3 x 20m/m_Tapping Screw	4
97	5/16" x UNC18 x 15L_Socket Head Cap Bolt	2

Dwg #	Part description	Q'ty
98	1/4" x 19m/m_Flat Washer	17
100	5 x 19m/m_Tapping Screw	2
101	1/4" x 13 x 1T_Flat Washer	8
102	1/4" _Split Washer	8
103	M6 x 15m/m_Phillips Head Screw	6
104	5/16" x 15m/m_Hex Head Bolt	2
105	Woodruff Key	2
106	3/8" x 2-1/4" _Button Head Socket Bolt	4
107	3/8" x 3-3/4" _Button Head Socket Bolt	6
108	3/8" x 23 x 2T_Curved Washer	6
109	3/8" x 19 x 1.5T_Flat Washer	4
110	M5 x 10m/m_Phillips Head Screw	8
111	M8 x 30m/m_Socket Head Cap Bolt	2
113	Ø3.5 x 12m/m_Sheet Metal Screw	18
117	3/8" x 3/4" _Hex Head Bolt	2
118	M10_Nut	2
119	M10 x 1.5(38mm)_Bolt	2
120	3/8" x 30 x 2.0T_Flat Washer	2
122	13.14m/m_Wrench	1
123	Combination M6 Allen Wrench & Phillips Head Screw	1
124	M12_L Allen Wrench	1
125	17m/m_Wrench	1
126	Phillips Head Screw Driver	1
127	12m/m_Wrench	1
130	3/8" x 16UNC-2_Flat Head Socket Bolt	4
133	5/16" x 18UNC x 12m/m_Nylock Screw	2
134	4 x 12m/m_Sheet Metal Screw	2
135	3 x 10m/m_Sheet Metal Screw	2
136	M14 x 2.0 x 7m/m_Nut	2
141	Ø18 x 8L_Idler Bolt	3
147	5 x 19m/m_Tapping Screw	2
148	Ø25 x 0.5T_Wave Washer	2